

hwam

intelligent heat

Since 1973



HWAM 3120c

 **MADE IN
DENMARK**

29-2107 UK

COLLECTION 2024





HWAM

intelligent heat

HWAM is a Danish supplier of hand-made quality wood-burning stoves and inserts. As a key element in the company, we develop and produce functional design solutions at our modern factory in Hørning in the heart of Denmark.

At HWAM, we focus on economic and climate-friendly combustion for the benefit of you and nature - now and in the future. A HWAM wood-burning stove offers you easy operation and provides warmth with a clear conscience.

CONTENTS

ABOUT HWAM

- 6 HWAM® Autopilot™
- 8 HWAM® SmartControl™
- 10 FAQ before choosing a wood-burning stove
- 13 Heat storage & stone cladding
- 14 Design your own HWAM wood-burning stove
- 16 Design and craftsmanship
- 18 Range overview

INSPIRATION

- 20 HWAM 2600
- 22 HWAM 3100
- 24 HWAM 3500
- 26 HWAM 3600
- 28 HWAM 3700
- 30 HWAM 4500
- 32 HWAM 4600
- 34 HWAM 5530
- 36 HWAM Classic 4
- 38 HWAM I 40/55
- 40 HWAM Accessories

TECHNICAL SPECIFICATIONS

- 42 HWAM 2600
- 44 HWAM 3100
- 46 HWAM 3500
- 47 HWAM 3600
- 50 HWAM 3700
- 52 HWAM 4500
- 55 HWAM 4600
- 57 HWAM 5530
- 59 HWAM Classic 4
- 60 HWAM I 40/55
- 61 Approvals & registrations
- 62 Product overview
- 64 Distance to combustible materials
- 66 Test results

10 series

HWAM wood-burning stoves come in 10 different stove series with heights between 70 and 168,50 cm. Choose a wall mounted, freestanding or modular model. Choose a model with or without side glass. Individualise your stove with a unique stone cladding. The choices are plentiful, no matter what style you are going for. Make your wood-burning stove dreams come true!

Which series is best suited to your personality?
Take a look and get inspired...



HWAM 3110c on steel bench



50 years of
quality, design &
production in Denmark.





CLEAN COMBUSTION AUTOMATICALLY WITH HWAM® AUTOPILOT™

A HWAM wood-burning stove holds a little secret. A secret which has been kept for 30-odd years. It is a heat-sensitive spring at the core of your HWAM wood-burning stove by the name of **HWAM® Autopilot™**.

Once you have lit the fire, **HWAM® Autopilot™** takes over and automatically regulates the air supply. As the heat rises and falls in the combustion chamber, the heat-sensitive spring will cause the three mechanical air dampers to open or close depending on the current temperature in the combustion chamber. In effect, optimum combustion without you having to do anything. Simply set the regulation to your heating requirements. Easy, convenient, eco-friendly and economical.

HWAM® Autopilot™ is standard in all HWAM wood-burning stoves and included in the price.



**SAVE
MONEY**



**PROTECT THE
ENVIRONMENT**



**EASY
OPERATION**

Learn more about **HWAM® Autopilot™** in this video:

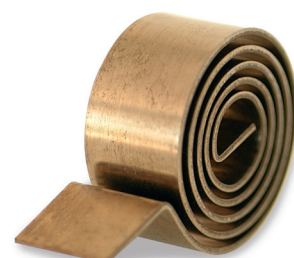

TIME FOR THE IMPORTANT THINGS IN LIFE? THE ANSWER IS HWAM® SMARTCONTROL™

HWAM® SmartControl™ adjusts the essential air supply in your wood-burning stove. All you have to do is light the fire and add new firewood. **HWAM® SmartControl™** will do the rest. You will get a message when it is time to add more firewood.

The oxygen meter and the temperature sensor, respectively, measures the level of oxygen and the temperature of the smoke and the smoke outlet. Both send a message to the airbox which regulates the dampers. A room sensor measures the temperature in the room, always leaving a pleasantly-heated room.

Learn more about **HWAM® SmartControl™** in this video:

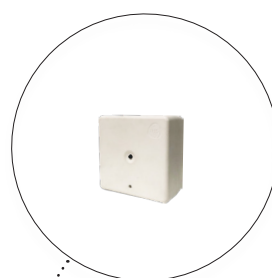

Room sensor



Airbox

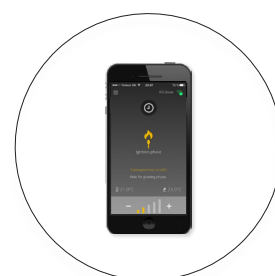

Smartphone or tablet



PROTECT THE ENVIRONMENT



SAVE MONEY



HIGH LEVEL OF COMFORT

WHAT TO CONSIDER BEFORE CHOOSING A WOOD-BURNING STOVE

Taste and style vary from person to person, so here we will let you be the expert. However, before you buy a wood-burning stove, there are a few things worth considering.

Why do you want a wood-burning stove?

Is it because you live in a cold house? Do you want to save money on the heating bill, or is it for the sake of the cosy atmosphere?

How many m² are to be heated?

It is important that the heat emitted by the wood-burning stove is adequate for the m² to be warmed up. As a rule of thumb, you can assume that approximately 1 kW is required to heat 20 m², provided the house is reasonably well insulated. Ask your HWAM dealer for more information.

How easy should it be?

All HWAM stoves are equipped with HWAM® Autopilot™ as standard, an automatic air control that ensures good combustion. If you would like it as easy as it comes, then choose a model with built-in HWAM® SmartControl™. The only thing you need to do is light the fire as usual, set the desired temperature via an app on your smartphone and then enjoy the heat and the dancing flames. You will receive a message through your app when it is time to add new firewood.

Requirements for the location?

Are there any special constructions in your home that render installation of the wood-burning stove impossible in certain areas? Is there anything you should be aware of in relation to combustible material?

Requirements for new houses?

If you live in a newly built house, you may need to install a fresh air system in your wood-burning stove, as newly built houses are very well insulated, and the air circulating in the house is often reused in the ventilation system. This means that there will not be enough air in the house for either lighting up nor combustion.

Requirements for chimney & smoke pipe

The chimney must be of a sufficient height to enable an adequate draft and to prevent smoke problems. The wood-burning stove requires a draft of at least 12 Pa. The chimney opening should always be at least the size of the outlet socket of the stove. The chimney must have an easily accessible soot door. Smoke pipe and chimney must always be suitable for a stove connection. Ask your HWAM retailer for more information.

Requirements for floors and/or walls

You should check whether the floor on which your wood-burning stove will be standing is stable enough to carry the weight, or whether the wall which your stove or insert will hang on/be built into is able to withstand weight. We recommend that you consult a specialist. If the wood-burning stove is placed on a flammable floor, make sure to protect the floor from embers falling out. You can choose tiles, sheet metal or a glass plate depending on what style you prefer. See more about distances to combustible material on page 64.

Ask an expert

Once you have considered some of these questions, it will hopefully be easier for you to make a decision. If you are still in doubt, you can always visit your local HWAM retailer for a talk about the right choice for you.



**WE BELIEVE IN FOCUSING ON
CLEAN COMBUSTION
FOR THE ENVIRONMENT
& THE FUTURE**





HEAT STORAGE & STONE CLADDING

When you choose a wood-burning stove with stone cladding, you get a stove with a unique appearance, since every stone has its own distinctive feature. Besides, there are other tangible benefits.

We know of heat storage from masonry stoves, where the heat is stored in the stones surrounding the combustion chamber. Heat storage in a wood-burning stove is the stove's ability to quickly and comfortably distribute the convection heat in the room combined with the masonry stove's capacity for heat storage.

Selected HWAM models are designed with a heat storage compartment that can be filled with stones with a special capacity for storing the heat from the wood-burning stove and then slowly give it off to the room. This means that you can enjoy the heat long after the fire has gone out.

If you want a wood-burning stove that stores the heat, you can choose one of the following HWAM models with natural stone cladding: 3520, 3640, 3660, 4540, 4560, 4640 and 4660.

If you would like a stove with a heat storage compartment, you can choose between these HWAM models: 3130, 3520, 3650, 3660, 3760, 4550, 4560, 4660 and 5530.

Below is an illustration of a wood-burning stove with and without heat-storing stones.

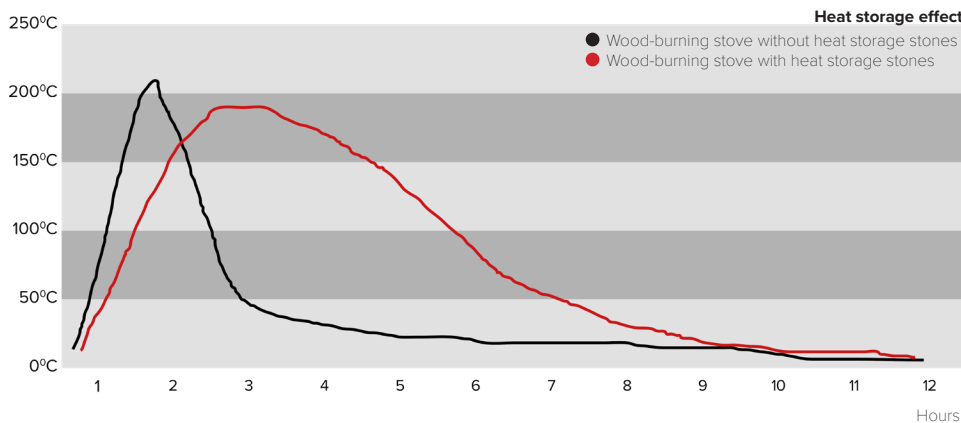
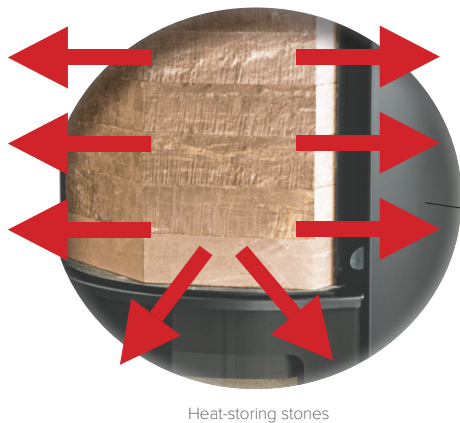

A wood-burning stove with heat storage stones means more continuous heat in the room with the same amount of firewood.



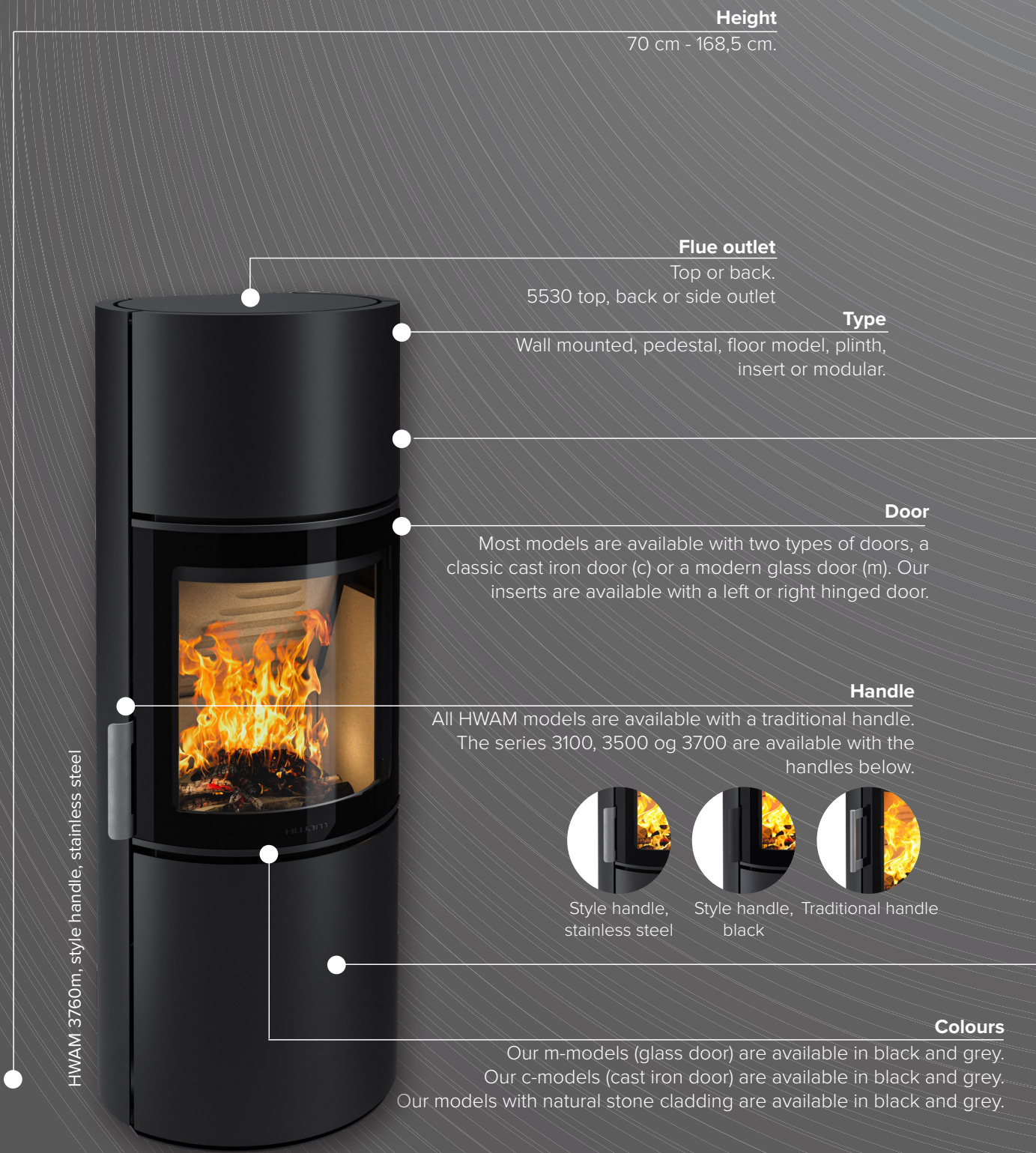

HWAM 3760m, style handle, stainless steel

Height

70 cm - 168,5 cm.

Flue outlet

Top or back.
5530 top, back or side outlet

Type

Wall mounted, pedestal, floor model, plinth,
insert or modular.

Door

Most models are available with two types of doors, a classic cast iron door (c) or a modern glass door (m). Our inserts are available with a left or right hinged door.

Handle

All HWAM models are available with a traditional handle. The series 3100, 3500 og 3700 are available with the handles below.



Style handle, stainless steel

Style handle, black

Traditional handle black

Colours

Our m-models (glass door) are available in black and grey.
Our c-models (cast iron door) are available in black and grey.
Our models with natural stone cladding are available in black and grey.

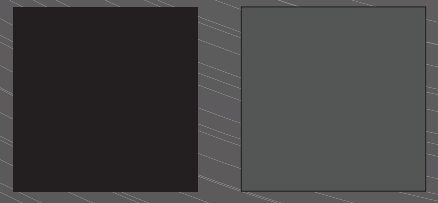

DESIGN YOUR OWN HWAM WOOD-BURNING STOVE

Once you have decided which model best suits your needs, it is time to choose the perfect look. There are many ways to tailor your stove to exactly fit your style and home. What do you prefer? A classic look? A raw look? Or a modern look?

Under our technical specifications from page 42, you can see all our models. Take a look at the possibilities and find inspiration on how to put together your very own HWAM model.

Natural stone cladding

A wood-burning stove with natural stone cladding has two functions. Visually, the stone creates a unique appearance, with no piece of stone being the same. Purely functionally, the heat-storing capacity of the stone extends the heat effect.



Soapstone



Tobacco

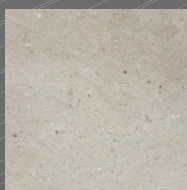

San Sebastian



Nox Petra

Function

All HWAM wood-burning stoves are equipped with HWAM® Autopilot™ as standard to help you achieve good combustion. As the temperature rises and falls in the combustion chamber, a bimetallic spring will expand and contract, thereby regulating the supply of air. When the fire is dying out, the damper will automatically open again, and you can add firewood or let the fire die out.

Would you like it as easy as it comes? Then you should choose a model with built-in HWAM® SmartControl™. HWAM® SmartControl™ is electronic control of the air for optimum combustion. The only thing you need to do is light the fire as usual, set the temperature via an app on your smartphone and enjoy the heat and the dancing flames. You will receive a message through the app when it is time to add more firewood.

DESIGN & CRAFTSMANSHIP



We believe that innovation and development go hand in hand with production. Take production out of the equation, and you lose the practical knowledge that makes it possible to translate design ideas into real stoves that meet aesthetic as well as functional needs and demands.

This is why all our wood-burning stoves and inserts are manufactured at our factory in Hørning and have been for almost 50 years. The process starts with our talented designers whom we have worked with for years. When their ideas and visions have manifested themselves in sketches, they open a dialogue with our designers and sales management for the development of a wood-burning stove or an insert that satisfies the demands of our customers.

Once the stove has been approved in relation to combustion and safety requirements, it will be put into production. Each single HWAM wood-burning stove is produced to order at our modern factory, and the processes are implemented and supervised by our highly skilled employees. This ensures a stable flow, better control of production and thus a final stove of outstanding quality.

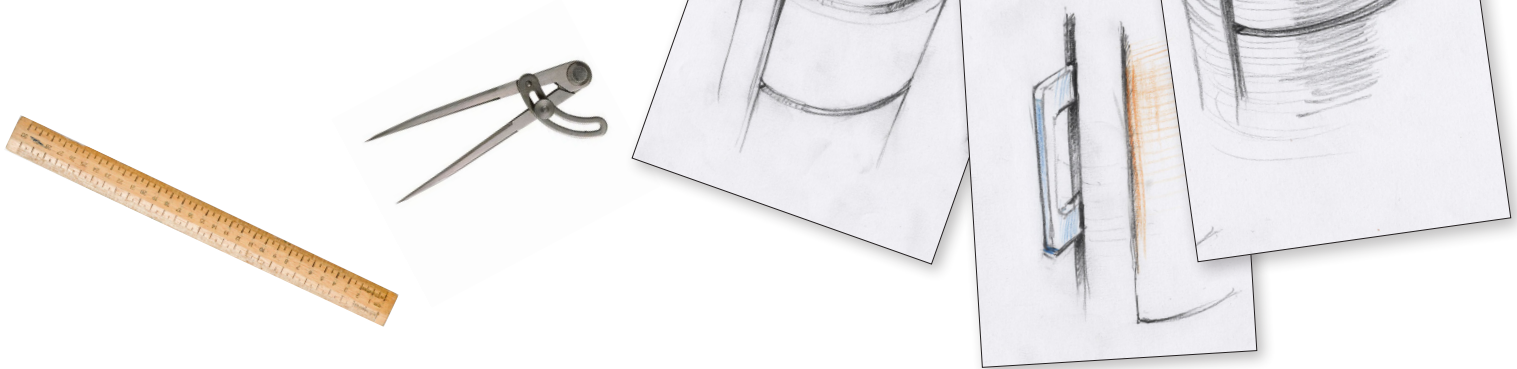

Sørig & Jacobsen



Anders C. Fasterholdt



 **MADE IN DENMARK**

RANGE OVERVIEW

HWAM 2600



HWAM 2610m



HWAM 2620c



HWAM 2630m



HWAM 2640c

HWAM 3100

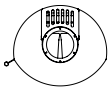

HWAM 3110c
Style handle,
stainless steel



HWAM 3110m



HWAM 3120c
Style handle,
black



HWAM 3130c

HWAM 3500

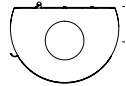

HWAM 3520m



HWAM 3520c
Soapstone cladding
Style handle

HWAM 3600

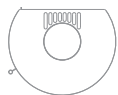

HWAM 3630m



HWAM 3640c



HWAM 3640c
Soapstone cladding



HWAM 3650m



HWAM 3660c



HWAM 3660m
Soapstone cladding

HWAM 3700

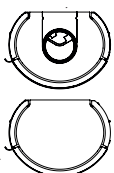

HWAM 3740m
Style handle
black



HWAM 3760c
Traditional handle

HWAM 4500

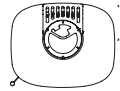

HWAM 4520c



HWAM 4510m
Low base



HWAM 4510c
Low plinth



HWAM 4520m
High plinth



HWAM 4530c



HWAM 4540m



HWAM 4540c
Soapstone
cladding



HWAM 4550m



HWAM 4560c



HWAM 4560c
Tobacco
stone cladding

HWAM 4600

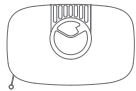

HWAM 4620c



HWAM 4640m



HWAM 4640m
Soapstone
cladding



HWAM 4660c



HWAM 4660c
Soapstone
cladding

HWAM 5530

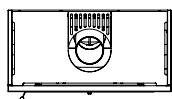

HWAM 5530c

HWAM I 40/55

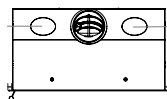

HWAM I 40/55c

HWAM Classic 4

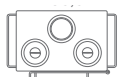

HWAM Classic 4



HWAM Classic 4
Wood store



HWAM Classic 4
Baking oven
& wood store



HWAM 2620c

With HWAM® Autopilot™
as standard

Specifications

Nominal heat output
Energy efficiency class
Width of combustion chamber

4.7 kW
A
27.0 cm

For more information on the HWAM 2600-series, see page 42.

HWAM 2600

Design: Sørig & Jacobsen

HWAM 2600 topview

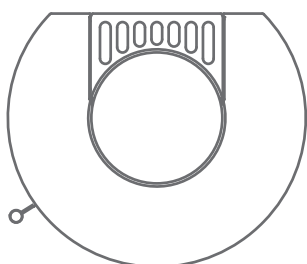

HWAM 2610c
with side glass
on a plinth
H 73.0 cm
W 43.0 cm
D 37.8 cm



HWAM 2610m
with side glass
H 70.0 cm
W 43.0 cm
D 37.8 cm



HWAM 2620c
on a pedestal
H 100.0 cm
W 43.0 cm
D 37.8 cm



HWAM 2630c
with side glass
H 100.0 cm
W 43.0 cm
D 37.8 cm



HWAM 2640c
H 100.0 cm
W 43.0 cm
D 37.8 cm



HWAM 2640m
H 100.0 cm
W 43.0 cm
D 37.8 cm



HWAM 3110c

With HWAM® Autopilot™
as standard and
HWAM® SmartControl™
as an option*

* Not HWAM 3110

Specifications

Nominal heat output - HWAM® Autopilot™ / HWAM® SmartControl™ 4.8 / 4.5 kW
Energy efficiency class - HWAM® Autopilot™ / HWAM® SmartControl™ **A** / **A+**
Width of combustion chamber 33.0 cm

For more information on the HWAM 3100-series, see page 44.

HWAM 3100

Design: Anders C. FASTERHOLDT

HWAM 3100 topview

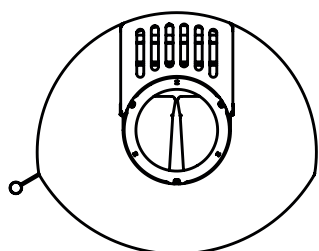

Handles



Style handle,
stainless steel



Style handle,
black

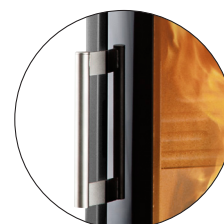

Traditional handle



HWAM 3110c
with style handle
stainless steel
H 75.5 cm
W 47.9 cm
D 41.4 cm



HWAM 3110c
on a plinth
H 83.5 cm
W 47.9 cm
D 41.4 cm



HWAM 3110m
on a pedestal
H 105.5 cm
W 47.7 cm
D 41.3 cm



HWAM 3120c
H 100.4 cm
W 47.7 cm
D 41.3 cm



HWAM 3120m
H 100.4 cm
W 47.7 cm
D 40.8 cm



HWAM 3130m
H 126.0 cm
W 47.5 cm
D 41.3 cm



With HWAM® Autopilot™
as standard and
HWAM® SmartControl™
as an option

HWAM 3520c

Specifications

Nominal heat output - HWAM® Autopilot™ / HWAM® SmartControl™ 4.8 / 4.5 kW
Energy efficiency class - HWAM® Autopilot™ / HWAM® SmartControl™ **A** / **A+**
Width of combustion chamber 33.0 cm

For more information on the HWAM 3500-series, see page 46.

HWAM 3500

Design: Sørig & Jacobsen

HWAM 3500 topview

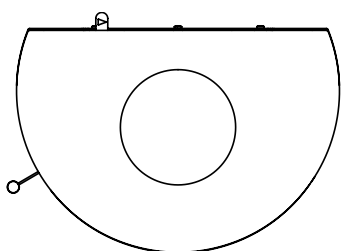

Handles



Style handle,
stainless steel



Style handle,
black

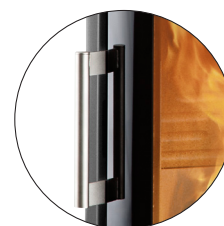

Traditional handle



HWAM 3520c
with style handle
stainless steel
H 126.0 cm
W 54.0 cm
D 37.5 cm



HWAM 3520m
H 126.0 cm
W 54.0 cm
D 37.5 cm



HWAM 3520c*
with soapstone
cladding
H 127.0 cm
W 54.0 cm
D 37.5 cm

Natural stone claddings

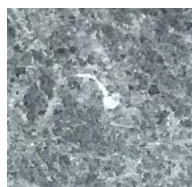

Soapstone

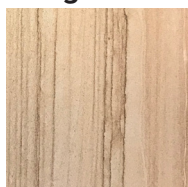

Tobacco



San Sebastian



Nox Petra



HWAM 3630m

With HWAM® Autopilot™
as standard and
HWAM® SmartControl™
as an option

Specifications

Nominal heat output

6.0 kW

Energy efficiency class - HWAM® Autopilot™ / HWAM® SmartControl™

A / A+

Width of combustion chamber

38.0 cm

For more information on the HWAM 3600-series, see page 47.

HWAM 3600

Design: Sørig & Jacobsen

HWAM 3600 topview

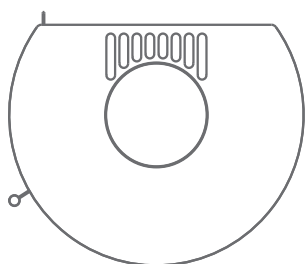

HWAM 3630c
with side glass
H 114.8 cm
W 55.6 cm
D 44.2 cm



HWAM 3640c
with soapstone
cladding
H 114.8 cm
W 60.0 cm
D 44.2 cm



HWAM 3640m
H 114.8 cm
W 55.6 cm
D 44.2 cm



HWAM 3650c
with side glass
H 150.8 cm
W 55.6 cm
D 44.2 cm



HWAM 3650m
with side glass
H 150.8 cm
W 55.6 cm
D 44.2 cm



HWAM 3660c
H 150.8 cm
W 55.6 cm
D 44.2 cm



HWAM 3660m
H 150.8 cm
W 55.6 cm
D 44.2 cm



HWAM 4560m
soapstone cladding
H 150.8 cm
W 60.0 cm
D 44.2 cm

Natural stone claddings

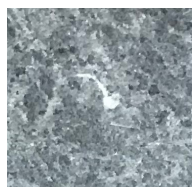

Soapstone

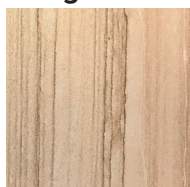

Tobacco



San Sebastian

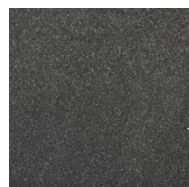

Nox Petra



With HWAM® Autopilot™
as standard and
HWAM® SmartControl™
as an option

HWAM 3740m

Specifications

Nominal heat output - HWAM® Autopilot™ / HWAM® SmartControl™	4.8 / 4.5 kW
Energy efficiency class - HWAM® Autopilot™ / HWAM® SmartControl™	A / A+
Width of combustion chamber	33.0 cm

For more information on the HWAM 3700-series, see page 50.

HWAM 3700

Design: Sørig & Jacobsen

HWAM 3700 topview

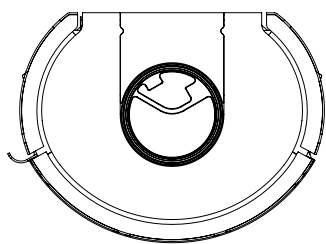

Handles



Style handle,
stainless steel



Style handle,
black

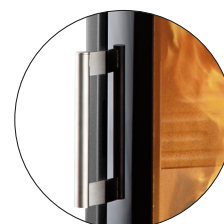

Traditional handle



Top outlet



Back outlet



HWAM 3740c
H 102.5 cm
W 49.9 cm
D 37.5 cm



HWAM 3740m
style handle,
stainless steel
H 102.5 cm
W 49.9 cm
D 37.5 cm



HWAM 3760m
H 125.4 cm
W 49.9 cm
D 37.5 cm



HWAM 3760m
style handle,
black
H 125.4 cm
W 49.9 cm
D 37.5 cm



HWAM 4520c on a low plinth

With HWAM® Autopilot™
as standard and
HWAM® SmartControl™
as an option

Specifications

Nominal heat output	4.9 kW
Energy efficiency class - HWAM® Autopilot™ / HWAM® SmartControl™	A / A+
Width of combustion chamber	35.8 cm

For more information on the HWAM 4500-series, see page 52.

HWAM 4500

Design: Sørig & Jacobsen

HWAM 4500 topview

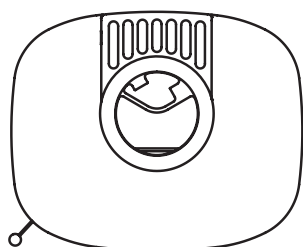

HWAM 4520c
H 75.5 cm
W 50.0 cm
D 40.6 cm



HWAM 4510c
with side glass &
on a low base
H 81.0 cm
W 50.0 cm



HWAM 4510c
with side glass &
on a low plinth
H 93.0 cm
W 50.0 cm
D 40.6 cm



HWAM 4520m
on a high plinth
H 104.0 cm
W 50.0 cm
D 40.6 cm



HWAM 4530c
with side glass
H 114.3 cm
W 50.0 cm
D 40.6 cm



HWAM 4540m
with side glass
H 114.3 cm
W 50.0 cm
D 40.6 cm



HWAM 4540c
with soapstone
cladding
H 114.3 cm
W 50.0 cm
D 40.6 cm



HWAM 4550m
with side glass
H 138.8 cm
W 50.0 cm
D 40.6 cm



HWAM 4560c
H 138.8 cm
W 50.0 cm
D 40.6 cm



HWAM 4560c
with Tobacco
cladding
H 138.8 cm
W 50.0 cm
D 40.6 cm

Natural stone claddings

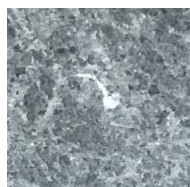

Soapstone

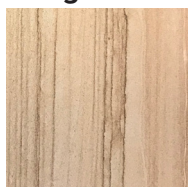

Tobacco



San Sebastian



Nox Petra



HWAM 4660c

With HWAM® Autopilot™
as standard and
HWAM® SmartControl™
as an option*

* Not HWAM 4620

Specifications

Nominal heat output - HWAM® Autopilot™ / HWAM® SmartControl™	7.0 / 8.0 kW
Energy efficiency class - HWAM® Autopilot™ / HWAM® SmartControl™	A / A+
Width of combustion chamber	49.0 cm

For more information on the HWAM 4600-series, see page 55.

HWAM 4600

Design: Sørig & Jacobsen

HWAM 4600 topview

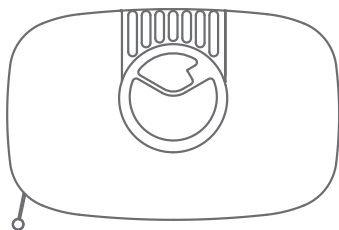

HWAM 4620c

H 84.8 cm
W 63.0 cm
D 40.6 cm



HWAM 4640m

with soapstone cladding
H 114.3 cm
W 63.0 cm
D 40.6 cm



HWAM 4640m

H 114.3 cm
W 63.0 cm
D 40.6 cm



HWAM 4660c

H 138.8 cm
W 63.0 cm
D 40.6 cm



HWAM 4660m

with Tobacco stone cladding
H 138.8 cm
W 63.0 cm
D 40.6 cm

Natural stone claddings

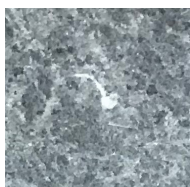

Soapstone

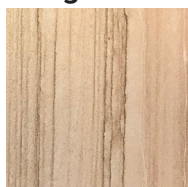

Tobacco



San Sebastian

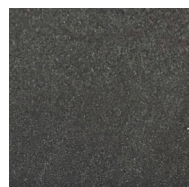

Nox Petra



HWAM 5530c

Specifications

Nominal heat output - HWAM® Autopilot™ / HWAM® SmartControl™

6.4 / 6.0 kW

Energy efficiency class - HWAM® Autopilot™ / HWAM® SmartControl™

A / A+

Width of combustion chamber

44.3-62.7 cm

For more information on the HWAM 5530, see page 57.

HWAM 5530

Design: Sørig & Jacobsen

HWAM 5530 topview

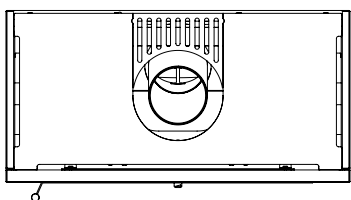

Narrow module
without drawer
H 48.5 cm
W 45.0 cm
D 45.0 cm



Narrow module
with drawer, oak front
H 48.5 cm
W 45.0 cm
D 45.0 cm



HWAM 5530m
right hinged door
H 168.5 cm
W 90.0 cm
D 45.0 cm



Tall module
H 168.5 cm
W 45.0 cm
D 45.0 cm



Wide module
without drawer
H 48.5 cm
W 90.0 cm
D 45.0 cm



Wide module
with drawer, oak front
H 48.5 cm
W 90.0 cm
D 45.0 cm

Drawer fronts

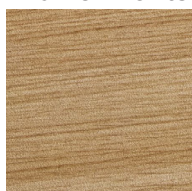

Oak

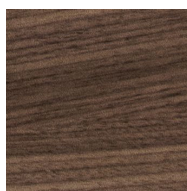

Walnut



Baking oven:
Achievable temperature
up to 240° C

With HWAM® Autopilot™
as standard and
fresh air system
as an option.

HWAM Classic 4 with baking oven and wood store

Specifications

Nominal heat output	8.0 kW
Energy efficiency class	A
Width of combustion chamber	40.0 cm

For more information on the HWAM Classic 4, see page 59.

HWAM Classic 4

Design: Anders C. FASTERHOLDT

HWAM Classic 4 topview

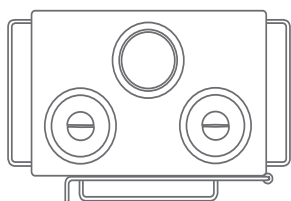

HWAM Classic 4

H 72.1 cm
W 60.0 cm
D 40.0 cm



HWAM Classic 4

with wood store
H 94.1 cm
W 60.0 cm
D 40.0 cm



HWAM Classic 4

with baking oven
and wood store
H 131.9 cm
B 60.0 cm
D 40.0 cm



Right or left hinged door

With HWAM® Autopilot™ as standard and HWAM® SmartControl™ as an option

Specifications

Nominal heat output - HWAM® Autopilot™ / HWAM® SmartControl™ 6.4 / 6.0 kW
Energy efficiency class - HWAM® Autopilot™ / HWAM® SmartControl™ **A** / **A+**
Width of combustion chamber 44.3-62.7 cm

For more information on the HWAM | 40/55, see page 60.

HWAM I 40/55

Design: Sørig & Jacobsen

HWAM I 40/55 topview

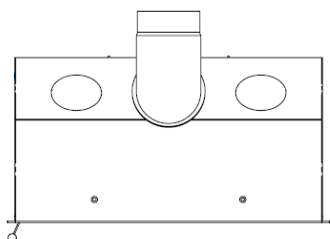

HWAM I 40/55c

left hinged door, standard frame
 H 56.9 cm
 W 77.0 cm
 D 39.6 cm

Customized frames

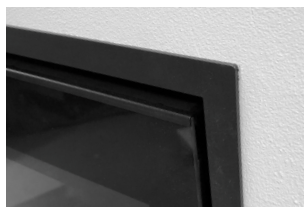

Standard 20 mm

Standard measures. This frame is integrated as standard if no customised frame is chosen.



Without bent edges

3 mm thick flat frame without bent edges. Made with customised measures with or without sides



With bent edges

Frame with bent edges. Made with customised measures with or without sides.



In-built depth of 35 cm

Standard measures. With this frame an in-built depth of 35 cm is achieved.



HWAM I 40/55m

right hinged door, standard frame
 H 56.9 cm
 W 77.0 cm
 D 39.6 cm

HWAM ACCESSORIES

Complete your HWAM wood-burning stove with accessories. A beautiful floor plate to match your choice of model perfectly or a practical and sculptural way of storing your firewood? Prolong the warmth of the fire with heat storing stones or have fresh air supplied from the outside for better combustion and a better indoor climate.

Firewood trolley

A HWAM Firewood trolley is a practical and robust helper when you transport firewood to your wood-burning stove. Thanks to its large wheels and a sturdy handle, it is easy to push the box, even when filled with wood. The design is elegant and matches all our stoves.

Firewood bucket

A classic and robust firewood bucket that will look decorative next to your wood-burning stove.

Wall-mounted firewood storage

If you want to keep your floor space, our round firewood storage solution will do the trick. Available in various sizes.

Floor plates

A tailor-made floor plate is available for most of our wood-burning stove models. We have developed floor plates in steel and glass adapted to the shape of your wood-burning stove. Aesthetically, the plates will match any interior design style, and they are easy to remove for cleaning purposes.

Heat storing stone

Selected HWAM models are designed with a heat storage compartment that can be filled with heat storing stone. This type of stone has a special ability to store the heat from the stove and slowly release it into the room. This means that you can enjoy the heat long after the fire has gone out. The models appear from the product overview on page 62.

Steel bench

Our new and exclusive steel bench is ideal when you want to raise your wood-burning stove from the floor. A bench height of 33.0 cm offers an excellent view of the flames and facilitates lighting up and re-stoking. Furthermore, your firewood can be handily stored underneath. The steel bench is made of steel and has a stylish matt black finish.



Wall-mounted firewood storage

Available in grey or black.
Ø 42.2 cm. D 27 or 35 cm
Ø 60.0 cm. D 27 or 35 cm

SmartBackup

The battery module, SmartBackup, is purchased separately and is easy to install on the HWAM® SmartControl™ system. We have developed this so we can offer you perfect security in relation to our technological system. We want it to be as easy and secure as possible for you to take advantage of technological combustion control in your HWAM stove. The battery means you are not dependent on the power supply, if there is a power outage.

Fresh air system

Many new or newly renovated houses are so well isolated that they may prevent the supply of combustion air from the room. As a consequence, the wood-burning stove will be lacking air. This may be remedied by connecting a fresh-air system to your wood-burning stove.

Steel bench

H 33.0 W 125.0 D 45.0 cm





Firewood trolley
H 87.5 W 50.5 D 38.5 cm



Firewood bucket
H 30.0 x Ø 42.8 cm
W incl. handle: 48.6 cm



Floor plates
Available in glass or steel.
Adapted to the shape of
your wood-burning stove.

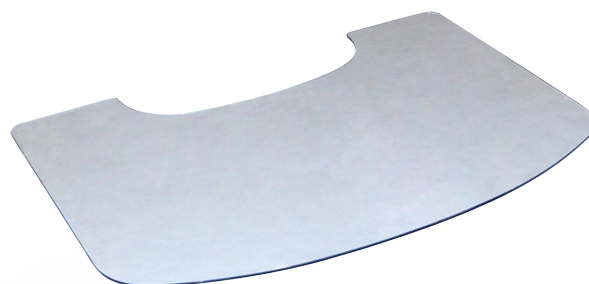

HWAM 2610/2620

Technical data

Nominal heat output	4.7 kW
Smoke outlet	Ø150 mm
Net efficiency	80.0%
Chimney draught, min. (recommended)	12 Pa
Energy efficiency class	A

Weight

Weight HWAM 2610c/2610m	66/64 kg
Weight HWAM 2620c/2620m	66/64 kg
Weight pedestal	15 kg

Measurements

Width of combustion chamber	27.0 cm
Connection from floor*, top	65.1 cm
Connection from floor on a plinth, top	68.1 cm
Connection from floor on a pedestal, top	95.1 cm
Connection from wall to center of top outlet, wall mounted	18.9 cm

* From the lower edge of the stove without plinth

Variants

Autopilot™
Classic door (c) or modern door (m)
Cast iron top, top outlet or back outlet
Pedestal, plinth or wall mounted
HWAM 2610/2620 are available in black and grey

Accessories

Fresh air kit, rear/bottom
5" flue outlet kit

Combustion system



HWAM 2610c
with side glass & on a plinth



HWAM 2610m
with side glass



HWAM 2620c
on a pedestal

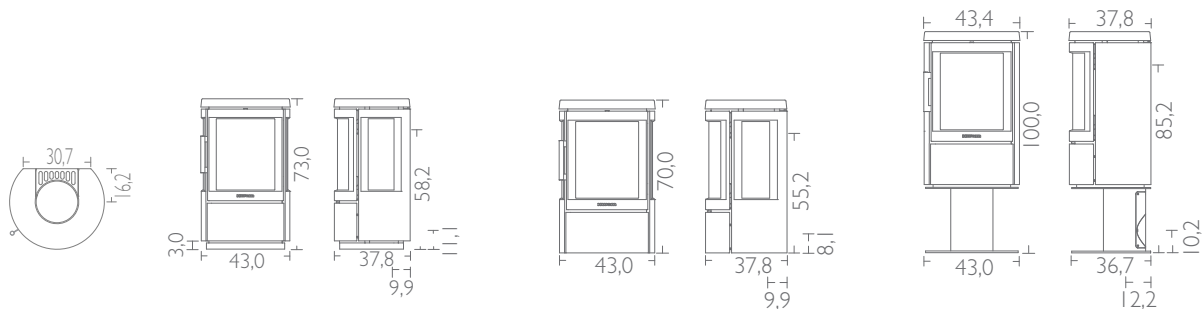

All drawings: The measurements for the flue outlet and fresh air connection are to the centre of the hole.

HWAM 2630/2640

Technical data

Nominal heat output	4.7 kW
Smoke outlet	Ø150 mm
Net efficiency	80.0%
Chimney draught, min. (recommended)	12 Pa
Energy efficiency class	A

Weight

Weight HWAM 2630c/2630m	75/73 kg
Weight HWAM 2640c/2640m	75/73 kg

Measurements

Width of combustion chamber	27.0 cm
Connection from floor, top	95.1 cm

Variants

- Autopilot™
- Classic door (c) or modern door (m)
- Cast iron top, top outlet or back outlet
- HWAM 2630/2640 are available in black and grey

Accessories

- Fresh air kit, rear/bottom
- 5" flue outlet kit

Combustion system



HWAM 2630c
with side glass



HWAM 2640c



HWAM 2640m

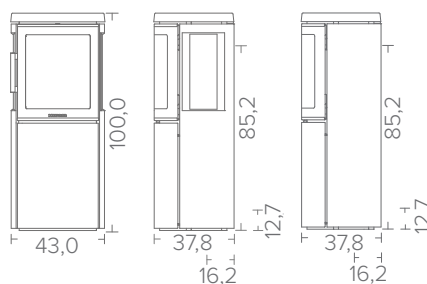
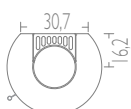

HWAM 3110

Technical data

Nominal heat output	4.8 kW
Smoke outlet	Ø150 mm
Net efficiency Autopilot™	79%
Chimney draught, min. (recommended)	12 Pa
Energy efficiency class	A

Weight

Weight HWAM 3110c/3110m	87/84 kg
Weight, pedestal	14 kg

Measurements

Width of combustion chamber	33.0 cm
Connection from floor*, top	69.8 cm
Connection from floor on a plinth, top	77.8 cm
Connection from floor on a pedestal, top	99.8 cm
Connection from wall to center of top outlet, wall-mounted	20.5 cm

* From the lower edge of the stove without plinth

Variants

Autopilot™
Classic door (c) or modern door (m)
Traditional handle (stainless steel) or style handle (stainless steel or black)
Cast iron top, top outlet or back outlet
Pedestal, plinth, wall bracket or corner wall bracket
HWAM 3110m is available in black and grey
HWAM 3110c is available in black and grey

Accessories

Fresh air kit, rear/bottom
5" flue outlet kit

Combustion system



HWAM 3110c on a plinth & with traditional handle



HWAM 3110m with traditional handle



HWAM 3110c on a pedestal & with style handle, black

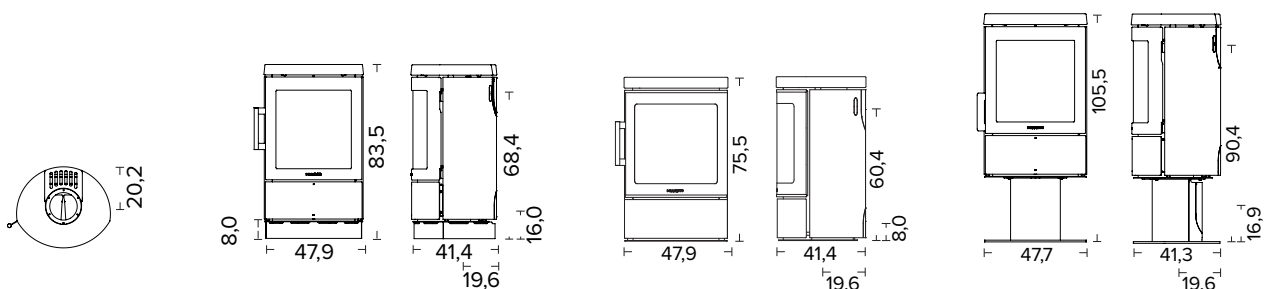

All drawings: The measurements for the flue outlet and fresh air connection are to the centre of the hole.

HWAM 3120/3130

Technical data

Nominal heat output - Autopilot™/SmartControl™	4.8/4.5 kW
Smoke outlet	Ø150 mm
Net efficiency - Autopilot™/ SmartControl™	79/81%
Chimney draught, min. (recommended)	12 Pa
Energy efficiency class - Autopilot™/SmartControl™	A/A+
Weight	
Weight HWAM 3120c/3120m	107/104 kg
Weight HWAM 3130c/3130m	113/110 kg
Weight, heat storage stones	Ca. 32 kg
Measurements	
Width of combustion chamber	33.0 cm
Connection from floor with Autopilot™, top	94.8 cm
Connection from floor with SmartControl™, top	97.5 cm

Variants

Autopilot™ or SmartControl™	
Classic door (c) or modern door (m)	
Traditional handle (stainless steel) or style handle (stainless steel or black)	
Cast iron top, top outlet or back outlet	
HWAM 3120m/3130m are available in black and grey	
HWAM 3120c/3130c are available in black and grey	
Accessories	
Fresh air kit, rear/bottom	
Heat storage stones (HWAM 3130)	
5" flue outlet kit	

Combustion system



HWAM 3120c
with style handle,
stainless steel



HWAM 3120m
with traditional handle



HWAM 3130m
with traditional handle

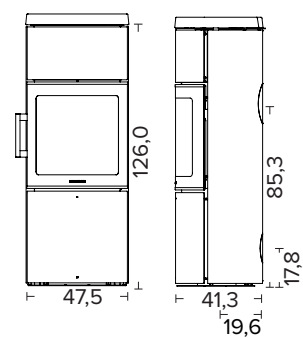
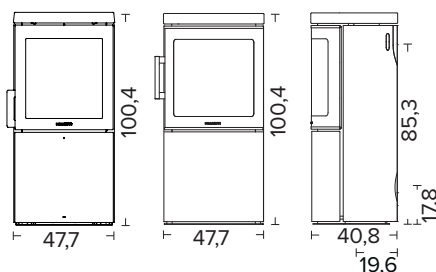
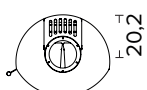

HWAM 3520

Technical data

Nominal heat output - Autopilot™/SmartControl™	4.8/4.5 kW
Smoke outlet	Ø150 mm
Net efficiency - Autopilot™/SmartControl™	79/81%
Chimney draught (recommended) - Autopilot™/SmartControl™	12/11 Pa
Energy efficiency class - Autopilot™/SmartControl™	A/A+

Weight

Weight HWAM 3520c/3520m	118/115 kg
Weight with soapstone cladding HWAM 3520c/3520m	167/164 kg
Weight with natural stone cladding HWAM 3520c/3520m	155/152 kg
Weight, heat storage stones	Ca. 44 kg

Measurements

Width of combustion chamber	33.0 cm
Connection from floor with Autopilot™, top	95.0 cm
Connection from floor with SmartControl™, top	97.7 cm

* At the time of the catalogue's publication HWAM 3520 with natural stone cladding is not UK CA approved for the UK market. Please see the latest update on www.hwam.com.

Variants

Autopilot™ or SmartControl™
Classic door (c) or modern door (m)
Traditional handle (stainless steel) or style handle (stainless steel or black)
Cast iron top, top outlet or back outlet
Soapstone cladding, top outlet or back outlet
Natural stone cladding, top outlet or back outlet*
HWAM 3520 is available in black and grey
HWAM 3520 with stone cladding is available in black and grey

Accessories

Fresh air kit, rear/bottom
Heat storage stones
5" flue outlet kit

Combustion system

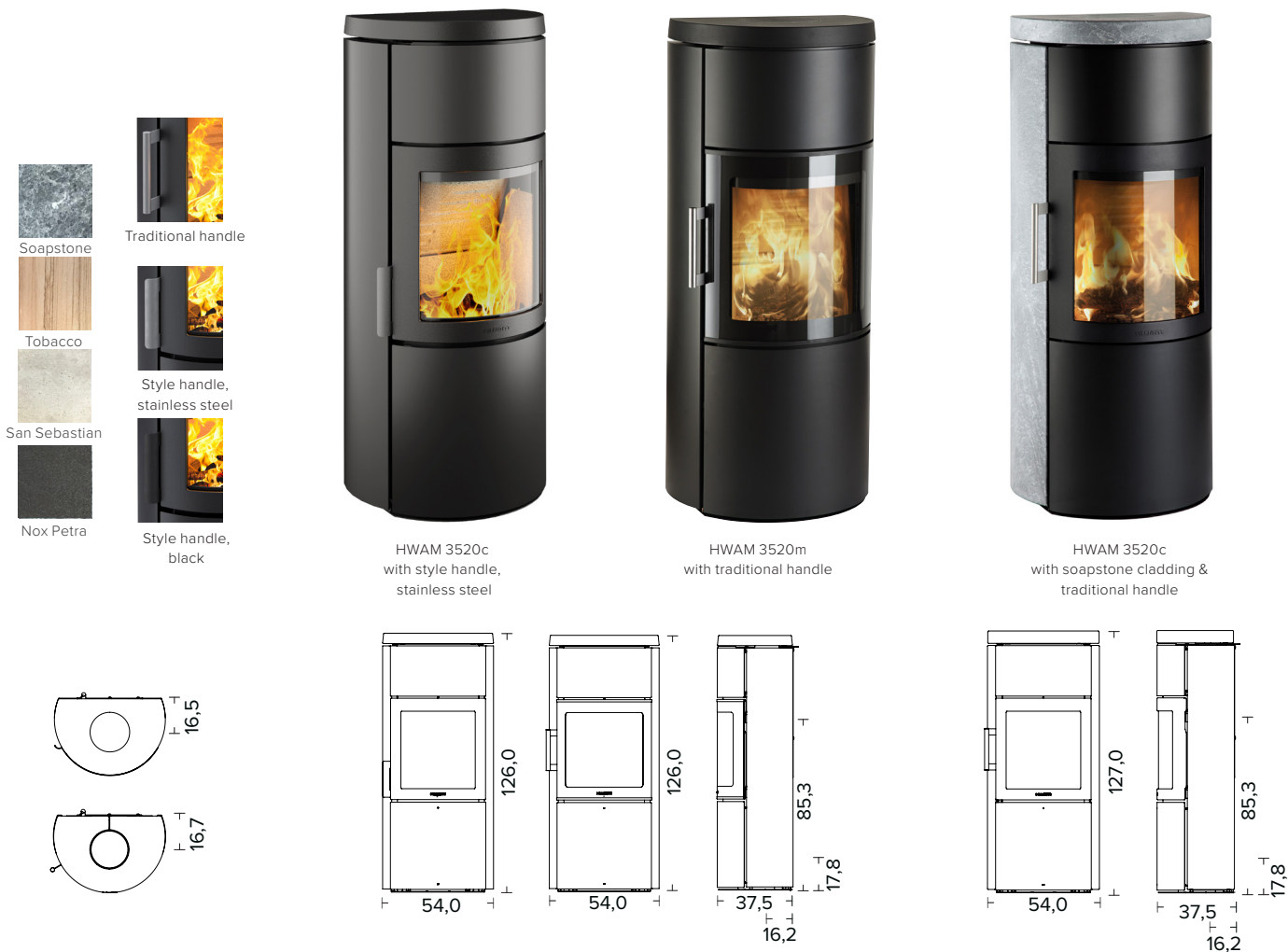

HWAM 3630/3640

Technical data

Nominal heat output	6.0 kW
Smoke outlet	Ø150 mm
Net efficiency Autopilot™/SmartControl™	78.3/80.7%
Chimney draught, min. (recommended) Autopilot™/SmartControl™	11/12 Pa
Energy efficiency class Autopilot™/SmartControl™	A/A+

Weight

Weight HWAM 3630c/3630m	139/136 kg
Weight HWAM 3640c/3640m	139/136 kg
Weight with soapstone cladding HWAM 3640c/3640m	229/226 kg
Weight with natural stone cladding HWAM 3640c/3640m	211/208 kg

Measurements

Width of combustion chamber	38.0 cm
Connection from floor with Autopilot™, top	109.6 cm
Connection from floor with SmartControl™, top	112.3 cm

Variants

- Autopilot™ or SmartControl™
- Classic door (c) or modern door (m)
- Cast iron top, top outlet or back outlet
- Soapstone cladding, top outlet or back outlet (HWAM 3640)
- Natural stone cladding, top outlet or back outlet (HWAM 3640)
- HWAM 3630/3640 are available in black and grey
- HWAM 3640 with stone cladding is available in black and grey

Accessories

- Fresh air kit, rear/bottom

Combustion system

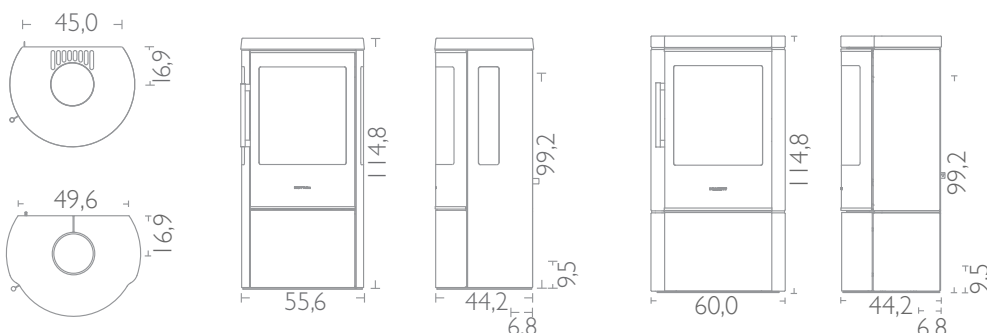

All drawings: The measurements for the flue outlet and fresh air connection are to the centre of the hole.

HWAM 3650

Technical data

Nominal heat output	6.0 kW
Smoke outlet	Ø150 mm
Net efficiency Autopilot™/ SmartControl™	78.3/80.7%
Chimney draught, min. (recommended) Autopilot™/SmartControl™	11/12 Pa
Energy efficiency class Autopilot™/SmartControl™	A/A+

Weight

Weight HWAM 3650c/3650m	171/168 kg
Weight, heat storage stones	Ca. 55 kg

Measurements

Width of combustion chamber	38.0 cm
Connection from floor with Autopilot™, top	109.6 cm
Connection from floor with SmartControl™, top	112.3 cm

Variants

- Autopilot™ or SmartControl™
- Classic door (c) or modern door (m)
- Cast iron top, top outlet or back outlet
- HWAM 3650 is available in black and grey

Accessories

- Fresh air kit, rear/bottom
- Heat storage stones

Combustion system



HWAM 3650c
with side glass

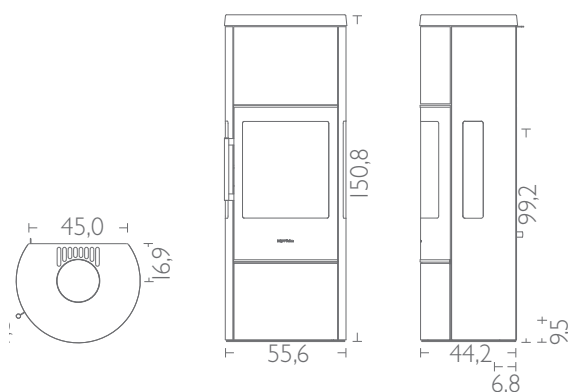

HWAM 3660

Technical data

Nominal heat output	6.0 kW
Smoke outlet	Ø150 mm
Net efficiency Autopilot™/SmartControl™	78.3/80.7%
Chimney draught, min. (recommended) Autopilot™/SmartControl™	11/12 Pa
Energy efficiency class Autopilot™/SmartControl™	A/A+

Weight

Weight HWAM 3660c/3660m	171/168 kg
Weight with soapstone cladding HWAM 3660c/3660m	282/279 kg
Weight with natural stone cladding HWAM 3660c/3660m	260/257 kg
Weight, heat storage stones	Ca. 55 kg

Measurements

Width of combustion chamber	38.0 cm
Connection from floor with Autopilot™, top	109.6 cm
Connection from floor with SmartControl™, top	112.3 cm

Variants

Autopilot™ or SmartControl™
Classic door (c) or modern door (m)
Cast iron top, top outlet or back outlet
Soapstone cladding, top outlet or back outlet
Natural stone cladding, top outlet or back outlet
HWAM 3660 is available in black and grey
HWAM 3660 with stone cladding is available in black and grey

Accessories

Fresh air kit, rear/bottom
Heat storage stones

Combustion system



HWAM 3660c



HWAM 3660m
with soapstone cladding

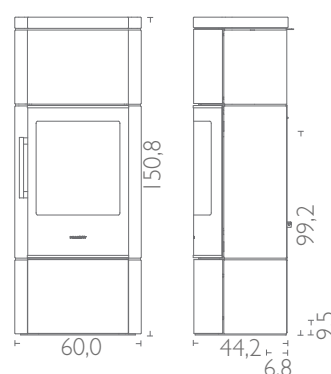
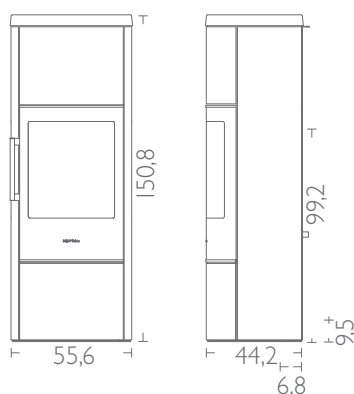
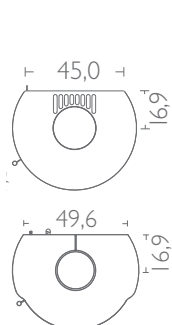

HWAM 3740

Technical data

Nominal heat output - Autopilot™/ SmartControl™	4.8/4.5 kW
Smoke outlet	Ø150 mm
Net efficiency - Autopilot™/ SmartControl™	79/81%
Chimney draught (recommended) - Autopilot™/ SmartControl™	12/11 Pa
Energy efficiency class - Autopilot™/SmartControl™	A/A+

Weight

Weight HWAM 3740c/3740m	104/101 kg
-------------------------	------------

Measurements

Width of combustion chamber	33.0 cm
Connection from floor with Autopilot™, top	94.8 cm
Connection from floor with SmartControl™, top	97.5 cm

Variants

Autopilot™ or SmartControl™
Classic door (c) or modern door (m)
Open or closed top (top outlet or back outlet)
Traditional handle (stainless steel) or style handle (stainless steel or black)
HWAM 3740 is available in black and grey

Accessories

Fresh air kit, rear/bottom

Combustion system

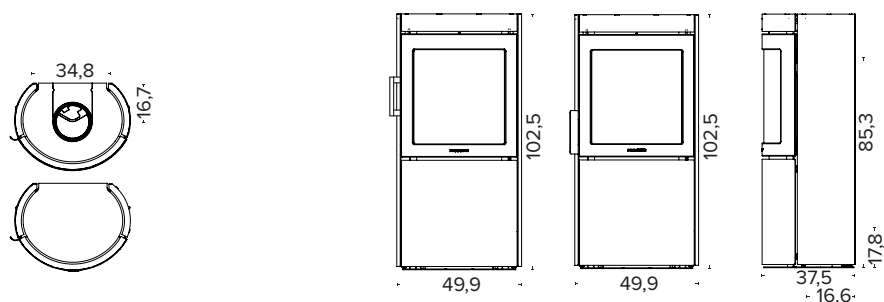

HWAM 3760

Technical data

Nominal heat output - Autopilot™/ SmartControl™	4.8/4.5 kW
Smoke outlet	Ø150 mm
Net efficiency - Autopilot™/ SmartControl™	79/81%
Chimney draught (recommended) - Autopilot™/ SmartControl™	12/11 Pa
Energy efficiency class - Autopilot™/SmartControl™	A/A+

Weight

Weight HWAM 3760c/3760m	117/113 kg
Weight, heat storing stones	Ca. 32 kg

Measurements

Width of combustion chamber	33.0 cm
Connection from floor with Autopilot™, top	94.8 cm
Connection from floor with SmartControl™, top	97.5 cm

* Only HWAM® SmartControl™

Variants

Autopilot™ or SmartControl™
Classic door (c) or modern door (m)
Open or closed top (top outlet or back outlet)
Traditional handle (stainless steel) or style handle (stainless steel or black)
HWAM 3740 is available in black and grey

Accessories

Fresh air kit, rear/bottom
Heat storage stones

Combustion system



HWAM 4510/4520

Technical data

Nominal heat output	4.9 kW
Smoke outlet	Ø150 mm
Net efficiency Autopilot™/ SmartControl™	82/81%
Chimney draught, min. (recommended)	12 Pa
Energy efficiency class Autopilot™/SmartControl™	A+/A+

Weight

Weight HWAM 4510c/4510m	101/99 kg
Weight HWAM 4520c/4520m	96/94 kg
Weight on a low base HWAM 4510c/4510m	103/101 kg
Weight on a low base HWAM 4520c/4520m	98/96 kg
Weight on a low plinth HWAM 4510c/4510m	105/103 kg
Weight on a low plinth HWAM 4520c/4520m	100/98 kg
Weight on a high plinth HWAM 4510c/4510m	109/107 kg
Weight on a high plinth HWAM 4520c/4520m	104/102 kg

* From the lower edge of the stove.

** Only wall mounted or on a plinth.

NB: Do not place low models of HWAM 4510/4520 on a flammable floor. Ask your local retailer for advise if in doubt.

Measurements

Width of combustion chamber	35.8 cm
Connection from floor without plinth, top, Autopilot™**	72.3 cm
Connection from floor without plinth, top, SmartControl™**	77.8 cm
Connection from floor low base, top	77.8 cm
Connection from floor low plinth, top	89.8 cm
Connection from floor high plinth, top	100.8 cm
Connection from wall to center of top outlet, wall mounted	21.3 cm

Variants

Autopilot™ or SmartControl™

Classic door (c) or modern door (m)

Cast iron top, top outlet or back outlet

Floor model, low base, low plinth, high plinth or wall mounted

HWAM 4510/4520 are available in black and grey

Accessories

Fresh air kit, rear/bottom

Combustion system



HWAM 4520c
HWAM® Autopilot™

HWAM 4510c
with side glass &
on a low base
HWAM® Autopilot™

HWAM 4510c
with side glass &
on a low plinth
HWAM® Autopilot™

HWAM 4520m
on a high plinth

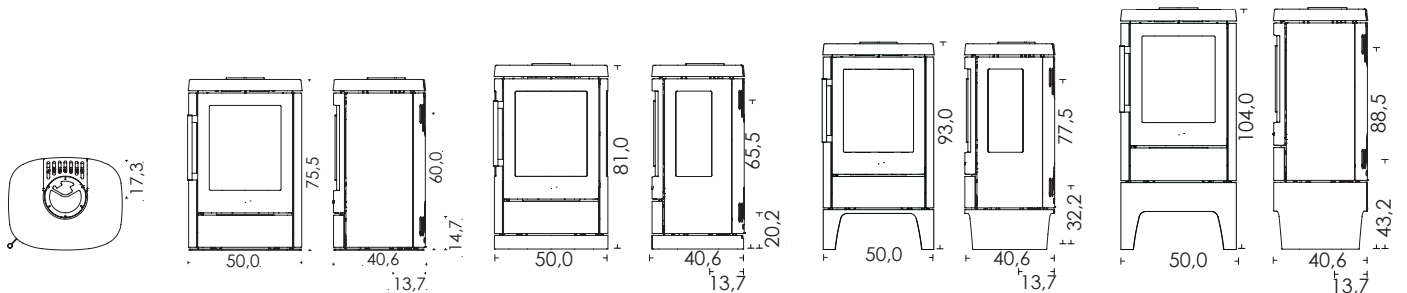

All drawings: The measurements for the flue outlet and fresh air connection are to the centre of the hole.

HWAM 4530/4540

Technical data

Nominal heat output	4.9 kW
Smoke outlet	Ø150 mm
Net efficiency Autopilot™/ SmartControl™	82/81%
Chimney draught, min. (recommended)	12 Pa
Energy efficiency class Autopilot™/SmartControl™	A+/A+

Weight

Weight HWAM 4530c/4530m	124/122 kg
Weight HWAM 4540c/4540m	119/117 kg
Weight with soapstone cladding HWAM 4540c/4540m	175/173 kg
Weight with natural stone cladding HWAM 4540c/4540m	136/134 kg

Measurements

Width of combustion chamber	35.8 cm
Connection from floor, top	111.4 cm

Variants

- Autopilot™ or SmartControl™
- Classic door (c) or modern door (m)
- Cast iron top, top outlet or back outlet
- Soapstone cladding, top outlet or back outlet (HWAM 4540)
- Natural stone cladding, top outlet or back outlet (HWAM 4540)
- HWAM 4530/4540 are available in black and grey
- HWAM 4540 with stone cladding is available in black and grey

Accessories

- Fresh air kit, rear/bottom

Combustion system

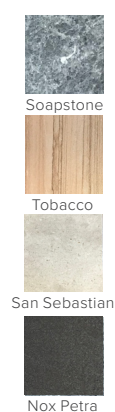

HWAM 4530c
with side glass



HWAM 4540m



HWAM 4540c
with soapstone cladding

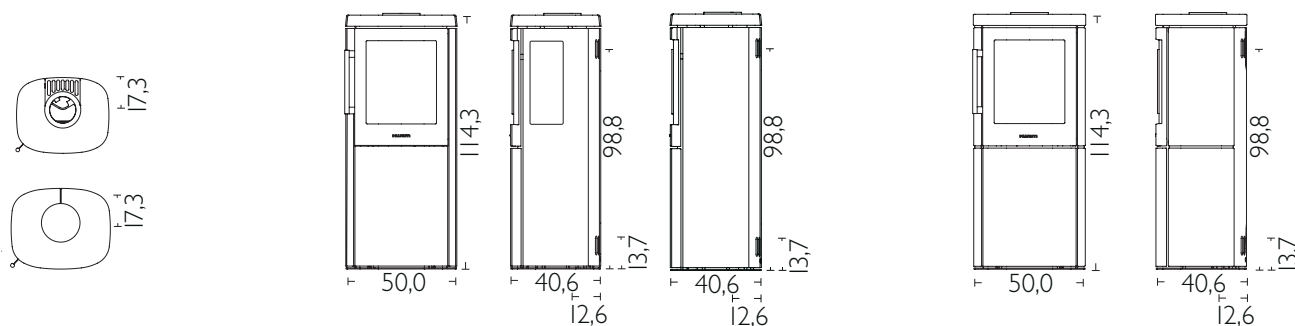

HWAM 4550/4560

Technical data

Nominal heat output	4.9 kW
Smoke outlet	Ø150 mm
Net efficiency Autopilot™/SmartControl™	82/81%
Chimney draught, min. (recommended)	12 Pa
Energy efficiency class Autopilot™/SmartControl™	A+/A+

Weight

Weight HWAM 4550c/4550m	134/132 kg
Weight HWAM 4560c/4560m	129/127 kg
Weight with soapstone cladding HWAM 4560c/4560m	201/199 kg
Weight with natural stone cladding HWAM 4560c/4560m	156/154 kg
Weight, heat storage stones	Ca. 29 kg

Measurements

Width of combustion chamber	35.8 cm
Connection from floor, top	111.4 cm

Variants

Autopilot™ or SmartControl™
Classic door (c) or modern door (m)
Cast iron top, top outlet or back outlet
Soapstone cladding, top outlet or back outlet (HWAM 4560)
Natural stone cladding, top outlet or back outlet (HWAM 4560)
HWAM 4550/4560 are available in black and grey
HWAM 4560 with stone cladding is available in black and grey

Accessories

Fresh air kit, rear/bottom
Heat storage stones

Combustion system

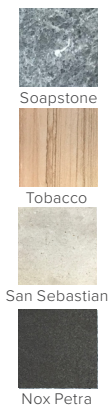

HWAM 4550m
with side glass



HWAM 4560c



HWAM 4560m
with soapstone cladding

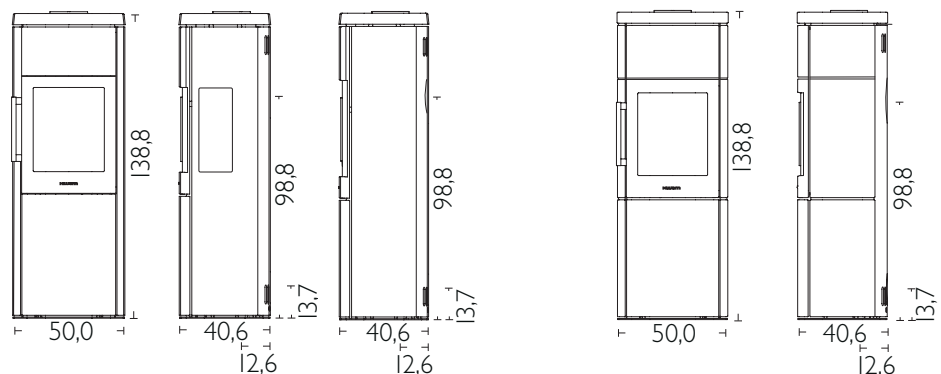
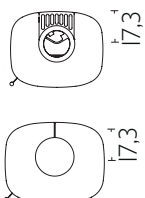

All drawings: The measurements for the flue outlet and fresh air connection are to the centre of the hole.

HWAM 4620/4640

Technical data

Nominal heat output Autopilot™/SmartControl™	7.0/8.0 kW
Smoke outlet	Ø150 mm
Net efficiency Autopilot™/ SmartControl™	80/81%
Chimney draught, min. (recommended)	12 Pa
Energy efficiency class Autopilot™/SmartControl™	A/A+

Weight

Weight HWAM 4620c/4620m	119/117 kg
Weight HWAM 4640c/4640m	133/131 kg
Weight with soapstone cladding HWAM 4640c/4640m	197/195 kg
Weight with natural stone cladding HWAM 4640c/4640m	182/180 kg

Measurements

Width of combustion chamber	49.0 cm
Connection from floor, top, HWAM 4620	81.9 cm
Connection from floor, top, HWAM 4640	111.4 cm

* Not HWAM 4620

Variants

Autopilot™ or SmartControl™
Classic door (c) or modern door (m)
Cast iron top, top outlet or back outlet
Soapstone cladding, top outlet or back outlet (HWAM 4640)
Natural stone cladding, top outlet or back outlet (HWAM 4640)
HWAM 4620/4640 are available in black and grey
HWAM 4640 with stone cladding is available in black and grey

Accessories

Fresh air kit, rear/bottom

Combustion system

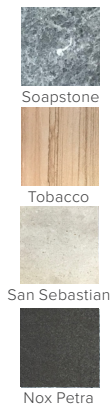

HWAM 4620c



HWAM 4640m



HWAM 4640m
with soapstone cladding

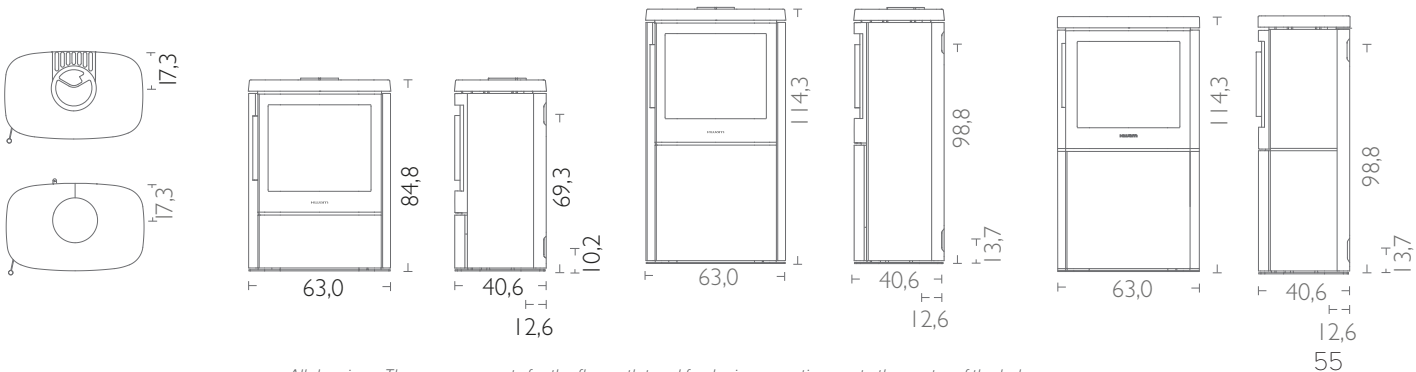

All drawings: The measurements for the flue outlet and fresh air connection are to the centre of the hole.

HWAM 4660

Technical data

Nominal heat output Autopilot™/SmartControl™	7.0/8.0 kW
Smoke outlet	Ø150 mm
Net efficiency Autopilot™/ SmartControl™	80/81%
Chimney draught, min. (recommended)	12 Pa
Energy efficiency class Autopilot™/SmartControl™	A/A+

Weight

Weight HWAM 4660c/4660m	153/151 kg
Weight with soapstone cladding HWAM 4660c/4660m	224/222 kg
Weight with natural stone cladding HWAM 4660c/4660m	209/207 kg
Weight, heat storage stones	Ca. 45 kg

Measurements

Width of combustion chamber	49.0 cm
Connection from floor, top	111.4 cm

Variants

Autopilot™ or SmartControl™
Classic door (c) or modern door (m)
Cast iron top, top outlet or back outlet
Soapstone cladding, top outlet or back outlet
Natural stone cladding, top outlet or back outlet
HWAM 4660 is available in black and grey
HWAM 4660 with stone cladding is available in black and grey

Accessories

Fresh air kit, rear/bottom
Heat storing stone

Combustion system

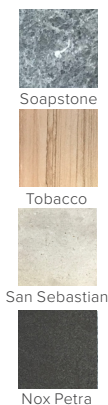

HWAM 4660c

HWAM 4660m
with Tobacco stone cladding

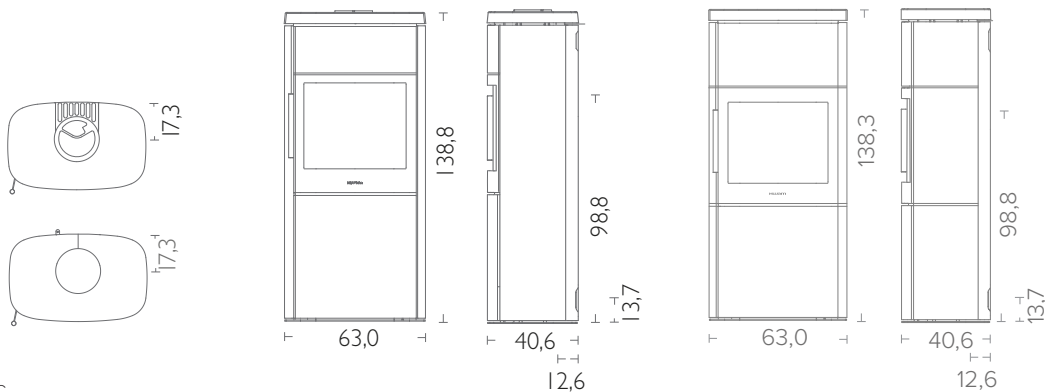

All drawings: The measurements for the flue outlet and fresh air connection are to the centre of the hole.

HWAM 5530

Technical data

Nominal heat output - Autopilot™/SmartControl™	6.4/6.0 kW
Smoke outlet	Ø150 mm
Net efficiency - Autopilot™/ SmartControl™	80/83%
Chimney draught, min.(recommended) - Autopilot™/ SmartControl™	11/12 Pa
Energy efficiency class - Autopilot™/SmartControl™	A/A+

Weight

Weight HWAM 5530c/5530m	247/245 kg
Weight tall bookcase	56 kg
Weight narrow module without/with drawer	25/37 kg
Weight wide module without/with drawer	45/55 kg
Weight, heat storage stones	Ca. 137 kg

Measurements

Width of combustion chamber	44.3-62.7 cm
Connection from floor, top,	160.0 cm

Variants

Autopilot™ or SmartControl™
Classic door (c) or modern door (m)
Optional right or left hinged door
Steel top, top outlet, back outlet or side outlet
HWAM 5530 is available in black

Accessories

Tall bookcase
Narrow module without/with drawer (front in oak/walnut) incl. felt cushion
Wide module without/with drawer (front in oak/walnut) incl. felt cushion
Heat storage stones
Fresh air kit, rear/bottom

Combustion system



HWAM 5530c
with right hinged door



HWAM 5530m
with right hinged door



Right hinged door



Left hinged door

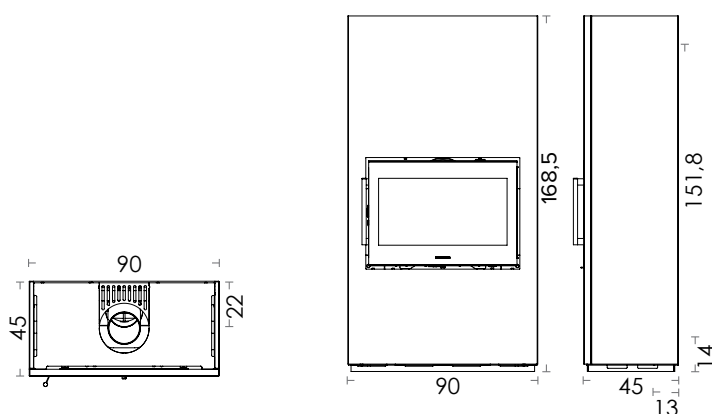

HWAM 5530

Setting Examples

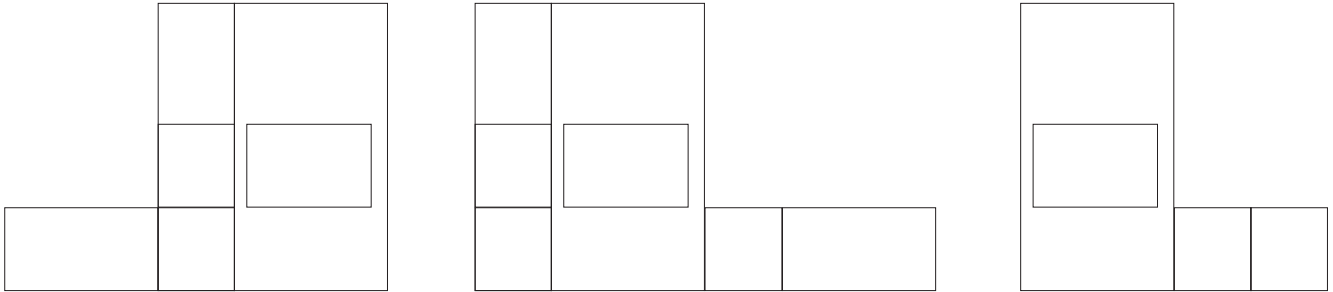

Tall bookcase



Narrow module without drawer



Narrow module with drawer, oak front



Narrow module with drawer, walnut front



Felt cushion for narrow module



Wide module without drawer



Wide module with drawer, oak front



Wide module with drawer, walnut front



Felt cushion for wide module

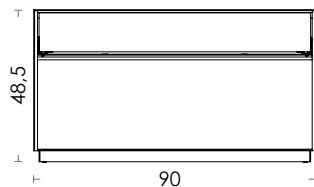
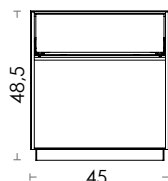
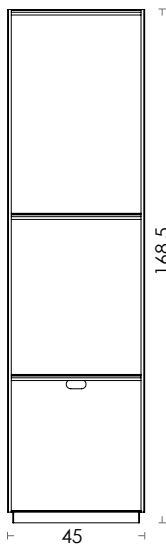

HWAM Classic 4

Technical data

Nominal heat output	8 kW
Smoke outlet	Ø150 mm
Net efficiency	79.3%
Chimney draught, min. (recommended)	12 Pa
Energy efficiency class	A
Weight	
Weight	108 kg
Weight with wood store	120 kg
Weight with a baking oven	178 kg
Weight with wood store and baking oven	190 kg

Measurements

Width of combustion chamber	40.0 cm
Baking oven, H x W x D	37,8 x 60,0 x 40,0 cm
Connection from floor, top*	68.7 cm
Connection from floor with wood store, top	90.7 cm
Connection from floor with baking oven, top	108.5 cm
Connection from floor with wood store and baking oven, top	130.5 cm

Variants

Autopilot™
Top outlet or back outlet (Baking oven only with top outlet)
Wood store
Baking oven
HWAM Classic 4 is available in black and grey

Accessories

Fresh air kit, rear

Combustion system



HWAM Classic 4



HWAM Classic 4
with wood store



HWAM Classic 4
with baking oven and wood store

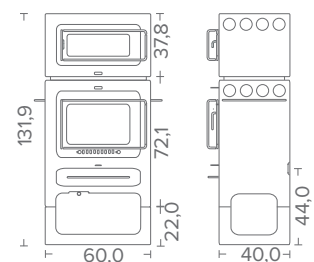
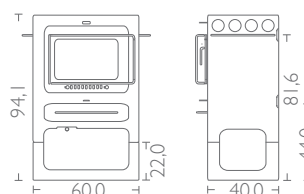
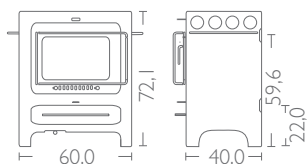
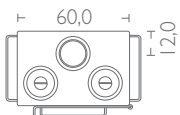

HWAM I 40/55

Technical data

Nominal heat output Autopilot™/SmartControl™	6.4/6.0 kW
Smoke outlet	Ø150 mm
Net efficiency Autopilot™/SmartControl™	80/83%
Chimney draught, min. (recommended) Autopilot™/SmartControl™	11/12 Pa
Energy efficiency class Autopilot™/SmartControl™	A/A+

Weight

Weight HWAM I 40/55c/I 40/55m	97/99 kg
-------------------------------	----------

Measurements

Width of combustion chamber	44.3-62.7 cm
-----------------------------	--------------

Variants

Autopilot™ or SmartControl™
Classic (c) or modern (m) door
Optional right or left hinged door
Top outlet or back outlet
HWAM I 40/55 is available in black

Accessories

Fresh air kit
Fan kit
Customised frame

Combustion system



HWAM I 40/55m right hinged door



HWAM I 40/55c left hinged door

HWAM® SmartControl™

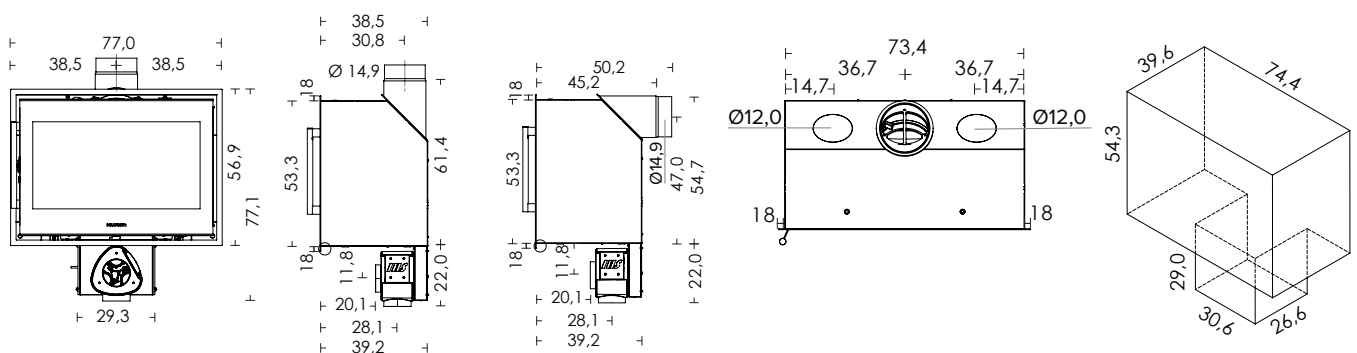

HWAM® Autopilot™

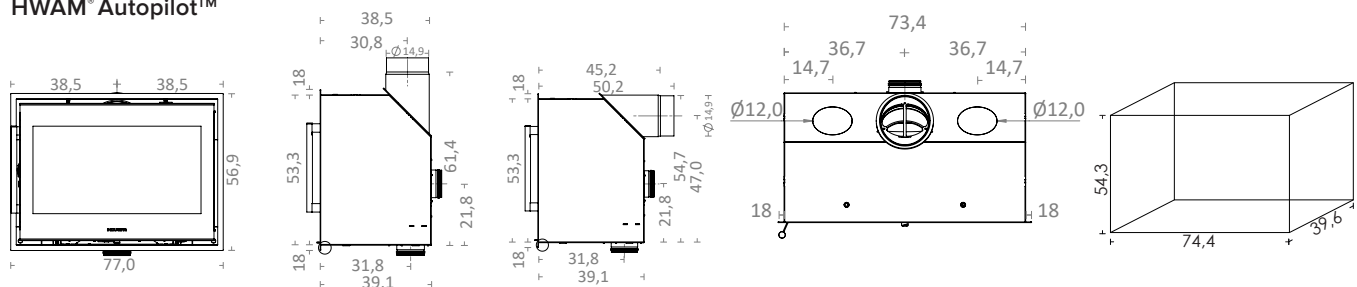

Approvals & registrations



	EN 13229 (Europa)	EN 13240 (Europa)	NS 3058/3059 (Norway)	LRV (Switzerland)	BimSchV Stufe 2 (Germany)	RLU zugelassen (Germany)	DEFRA exempt (UK)	UK CA (UK)	Flamme Verte (France)	Conto termico (Italy)	Classificazione (Italy)	ECO Design 2022
HWAM 2610		x	x	x	x		x	x	x		3	x
HWAM 2620		x	x	x	x		x	x	x		3	x
HWAM 2630		x	x	x	x	x	x	x	x		3	x
HWAM 2640		x	x	x	x	x	x	x	x		3	x
HWAM 3110		x	x	x	x		x	x	x		3	x
HWAM 3120		x	x	x	x	x	x ⁽¹⁾	x	x		4 ⁽²⁾	x
HWAM 3130		x	x	x	x	x		x	x		4 ⁽²⁾	x
HWAM 3520		x	x	x	x	x	x ⁽¹⁾	x	x		4 ⁽²⁾	x
HWAM 3630		x	x	x	x	x	x ⁽¹⁾	x	x		4	x
HWAM 3640		x	x	x	x	x	x ⁽¹⁾	x	x		4	x
HWAM 3650		x	x	x	x	x	x ⁽¹⁾	x	x		4	x
HWAM 3660		x	x	x	x	x	x ⁽¹⁾	x			4	x
HWAM 3740		x	x	x	x			x	x		4 ⁽²⁾	x
HWAM 3760		x	x	x	x			x	x		4 ⁽²⁾	x
HWAM 4510		x	x	x	x	x	x	x			4 ⁽²⁾	x
HWAM 4520		x	x	x	x	x	x	x			4 ⁽²⁾	x
HWAM 4530		x	x	x	x	x	x	x			4 ⁽²⁾	x
HWAM 4540		x	x	x	x	x	x	x	x		4 ⁽²⁾	x
HWAM 4550		x	x	x	x	x	x	x			4 ⁽²⁾	x
HWAM 4560		x	x	x	x	x	x	x	x		4 ⁽²⁾	x
HWAM 4620		x	x	x	x	x	x	x	x		3	x
HWAM 4640		x	x	x	x	x	x	x	x		3	x
HWAM 4660		x	x	x	x	x	x	x	x		3	x
HWAM 5530		x	x	x	x	x	x	x	x	x	4	x
HWAM Classic 4		x		x	x			x	x		-	x
HWAM I 40/55	x		x	x	x	x	x	x	x	x	4	x

(1) Applies only to models with HWAM® Autopilot™.
 (2) HWAM® SmartControl™ 4 stars. HWAM® Autopilot™ 3 stars.

NB! The table shows the status at the time of the catalogue's publication.

At the time of printing (June 2022) HWAM stoves were being put forward for UK CA approval.
 The current status can be obtained at any time from your HWAM dealer and can be checked on www.hwam.com.

Product overview

	Function					Design											Connection			
	Nominal heat output <5 kW	Nominal heat output 5-6 kW	Nominal heat output >6 kW	HWAM® Autopilot™	HWAM® SmartControl™	Classic door	Modern door	Side hinged door	Optional handle	Optional right or left hinged door	Side glass	Wall-mounted	Pedestal or/and plinth	Heat storage compartment	Grey	Black	Soapstone cladding/Natural stone cladding	Wood store and/or baking oven	Fresh air kit, bottom	Fresh air kit, rear
HWAM 2610c	x			x		x		x			x	x	x		x	x			x	x
HWAM 2610m	x			x			x	x			x	x	x		x	x			x	x
HWAM 2620c	x			x		x		x				x	x		x	x			x	x
HWAM 2620m	x			x			x	x				x	x		x	x			x	x
HWAM 2630c	x			x		x		x			x				x	x			x	x
HWAM 2630m	x			x			x	x			x				x	x			x	x
HWAM 2640c	x			x		x		x							x	x			x	x
HWAM 2640m	x			x			x	x							x	x			x	x
HWAM 3110c	x			x		x		x	x			x	x		x	x			x	x
HWAM 3110m	x			x			x	x	x			x	x		x	x			x	x
HWAM 3120c	x			x	x	x		x	x						x	x			x	x
HWAM 3120m	x			x	x		x	x	x						x	x			x	x
HWAM 3130c	x			x	x	x		x	x				x		x	x			x	x
HWAM 3130m	x			x	x		x	x	x				x		x	x			x	x
HWAM 3520c	x			x	x	x		x	x				x		x	x	x		x	x
HWAM 3520m	x			x	x		x	x	x				x		x	x	x		x	x
HWAM 3630c		x		x	x	x		x			x				x	x			x	x
HWAM 3630m		x		x	x		x	x			x				x	x			x	x
HWAM 3640c		x		x	x	x		x							x	x	x		x	x
HWAM 3640m		x		x	x		x	x							x	x	x		x	x
HWAM 3650c		x		x	x	x		x			x		x		x	x			x	x
HWAM 3650m		x		x	x		x	x			x		x		x	x			x	x
HWAM 3660c		x		x	x	x		x					x		x	x	x		x	x
HWAM 3660m		x		x	x		x	x					x		x	x	x		x	x
HWAM 3740c	x			x	x	x		x	x						x	x			x	x
HWAM 3740m	x			x	x		x	x	x						x	x			x	x
HWAM 3760c	x			x	x	x		x	x				x		x	x			x	x
HWAM 3760m	x			x	x		x	x	x				x		x	x			x	x

Product overview

	Function					Design										Connection				
	Nominal heat output <5 kW	Nominal heat output 5-6 kW	Nominal heat output >6 kW	HWAM® Autopilot™	HWAM® SmartControl™	Classic door	Modern door	Side hinged door	Optional handle	Optional right or left hinged door	Side glass	Wall-mounted	Pedestal or/and plinth	Heat storage compartment	Grey	Black	Soapstone cladding/Natural stone cladding	Wood store and/or baking oven	Fresh air kit, bottom	Fresh air kit, rear
HWAM 4510c	x			x	x	x		x			x	x	x		x	x			x	x
HWAM 4510m	x			x	x		x	x			x	x	x		x	x			x	x
HWAM 4520c	x			x	x	x		x			x	x			x	x			x	x
HWAM 4520m	x			x	x		x	x			x	x			x	x			x	x
HWAM 4530c	x			x	x	x		x			x				x	x			x	x
HWAM 4530m	x			x	x		x	x			x				x	x			x	x
HWAM 4540c	x			x	x	x		x							x	x	x		x	x
HWAM 4540m	x			x	x		x	x							x	x	x		x	x
HWAM 4550c	x			x	x	x		x			x		x	x	x	x			x	x
HWAM 4550m	x			x	x		x	x			x		x	x	x	x			x	x
HWAM 4560c	x			x	x	x		x					x	x	x	x			x	x
HWAM 4560m	x			x	x		x	x					x	x	x	x			x	x
HWAM 4620c		x	x			x		x							x	x			x	x
HWAM 4620m		x	x				x	x							x	x			x	x
HWAM 4640c		x	x	x		x		x							x	x	x		x	x
HWAM 4640m		x	x	x			x	x							x	x	x		x	x
HWAM 4660c		x	x	x		x		x					x	x	x	x			x	x
HWAM 4660m		x	x	x			x	x					x	x	x	x			x	x
HWAM 5530c		x	x	x	x	x		x		x			x		x				x	x
HWAM 5530m		x	x	x	x		x	x		x			x		x				x	x
HWAM Classic 4			x	x				x							x	x		x		x
HWAM I 40/55c		x	x	x	x	x		x		x						x			x	x ¹⁾
HWAM I 40/55m		x	x	x	x		x	x		x						x			x	x ¹⁾

1) HWAM® SmartControl™: See drawing.

Distance to combustible materials

- insulated flue gas pipe/uninsulated flue gas pipe

	1. Behind Cm. min	2. Side Cm. min.	5. Side, in front of the stove Cm. min.	3. Distance to furnishing in front Cm. min.	4. Above combustible floor Cm. min.	Distance to mantel piece (UK) Cm. min.	May be installed on a 12 mm thick hearth on combustible floor (UK)	6. Distance to combustible wall, corner location Cm. min	7. Distance to combustible wall, corner location Cm. min.
HWAM 2610	10/20	45/50	45/50	90	3 ⁽²⁾	45	x ⁽⁶⁾	40/40	62/62
HWAM 2620	7.5/17.5	16/16	40/40	95	3 ⁽²⁾	50	x ⁽⁶⁾	12.5/12.5	34/34
HWAM 2630	10/20	45/50	45/50	90	-	45	x	40/40	62/62
HWAM 2640	7.5/17.5	16/16	40/40	95	-	50	x	12.5/12.5	34/34
HWAM 3110	7.5/12.5	22/25.5	45/45	105	8 ⁽²⁾	45	x ⁽⁶⁾	10/12.5	31/34
HWAM 3120	7.5/12.5	22/25.5	45/45	105	-	45	x	10/12.5	31/34
HWAM 3120 - HWAM® SmartControl™	7.5/10	19.5/19.5	40/40	100	-	45	x	10/10	31/31
HWAM 3130	7.5/12.5	22/25.5	45/45	105	-	45	x	10/12.5	31/34
HWAM 3130 - HWAM® SmartControl™	7.5/10	19.5/19.5	40/40	100	-	45	x	10/10	31/31
HWAM 3520	11.5/16.5	22/25.5	45/45	105	-	45	x	10/12.5	39/42
HWAM 3520 - HWAM® SmartControl™	11.5/14	19.5/19.5	40/40	100	-	45	x	10/10	39/39
HWAM 3630	10	40	40	90	-	-	x	35 ⁽¹⁾	63 ⁽¹⁾
HWAM 3640	10	40	40	90	-	-	x	20 ⁽¹⁾	48 ⁽¹⁾
HWAM 3650	10	40	40	90	-	-	x	35 ⁽¹⁾	63 ⁽¹⁾
HWAM 3660	10	40	40	90	-	-	x	20 ⁽¹⁾	48 ⁽¹⁾
HWAM 3740	11.5/16.5	22/25.5	45/45	105	-	45	x	10/12.5	34/37
HWAM 3740 - HWAM® SmartControl™	11.5/14	19.5/19.5	40/40	100	-	45	x	10/10	34/34
HWAM 3760	11.5/16.5	22/25.5	45/45	105	-	45	x	10/12.5	34/37
HWAM 3760 - HWAM® SmartControl™	11.5/14	19.5/19.5	40/40	100	-	45	x	10/10	34/34

(1) **Important!** All dimensions in connection with corner installation are only recommendations.

(2) This distance requirement is met when the stove is mounted on a plinth or a pedestal.

(3) With insulated flue pipe

(4) This distance requirement is met when the stove is mounted on a high plinth.

(5) Distance to non combustible insulation against combustible wall.

(6) Can be installed on a 12 mm hearth, when mounted on a plinth.

(7) Can be installed on a 12 mm hearth when mounted on a low plinth.

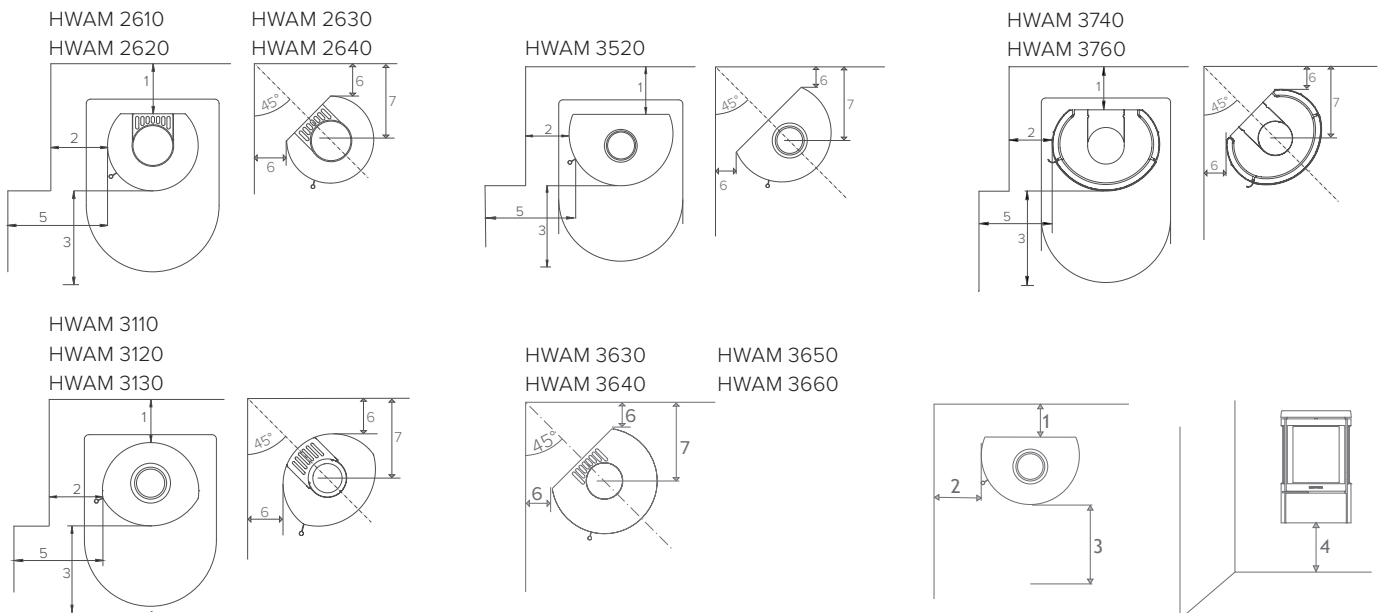

Distance to combustible materials

- insulated flue gas pipe/uninsulated flue gas pipe

	1. Behind Cm. min	2. Side Cm. min.	5. Side, in front of the stove Cm. min.	3. Distance to furnishing in front Cm. min.	4. Above combustible floor Cm. min.	Distance to mantel piece (UK) Cm. min.	May be installed on a 12 mm thick hearth on combustible floor (UK)	6. Distance to combustible wall, corner location Cm. min.	7. Distance to combustible wall, corner location Cm. min.
HWAM 4510	10	59	59	120	28.5 ⁽⁴⁾	-	x ⁽⁷⁾	33	57
HWAM 4520	10	35	35	110	28.5 ⁽⁴⁾	-	x ⁽⁷⁾	7	31
HWAM 4530	10	59	59	120	-	-	x	33	57
HWAM 4540	10	35	35	110	-	-	x	7	31
HWAM 4540, stone cladding	10	40	40	110	-	-	x	7	31
HWAM 4550	10	59	59	120	-	-	x	33	57
HWAM 4560	10	35	35	110	-	-	x	7	31
HWAM 4560, stone cladding	10	40	40	110	-	-	x	7	31
HWAM 4620	7 ⁽³⁾ /20	40 ⁽³⁾ /35	40 ⁽³⁾ /35	130	-	-	x	12 ⁽³⁾ /12	41 ⁽³⁾ /41
HWAM 4640	7 ⁽³⁾ /20	40 ⁽³⁾ /35	40 ⁽³⁾ /35	130	-	-	x	12 ⁽³⁾ /12	41 ⁽³⁾ /41
HWAM 4640, stone cladding	7 ⁽³⁾ /20	45 ⁽³⁾ /45	45 ⁽³⁾ /45	140	-	-	x	15 ⁽³⁾ /15	44 ⁽³⁾ /44
HWAM 4660	7 ⁽³⁾ /20	40 ⁽³⁾ /35	40 ⁽³⁾ /35	130	-	-	x	12 ⁽³⁾ /12	41 ⁽³⁾ /41
HWAM 4660, stone cladding	7 ⁽³⁾ /20	45 ⁽³⁾ /45	45 ⁽³⁾ /45	140	-	-	x	15 ⁽³⁾ /15	44 ⁽³⁾ /44
HWAM 5530	0/5	0	0	120	-	-	x	0	47.7
HWAM Classic 4	10	25	25	80	-	-	x	10 ⁽¹⁾	39 ⁽¹⁾
HWAM I 40/55	5 ⁽⁵⁾	5 ⁽⁵⁾	5 ⁽⁵⁾	120	35	-	-	-	-

HWAM 4510
HWAM 4520
HWAM 4530

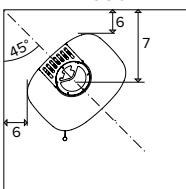

HWAM 4540
HWAM 4550
HWAM 4560

HWAM 4620
HWAM 4640
HWAM 4660

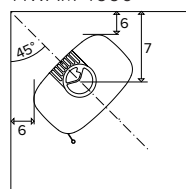

HWAM 5530

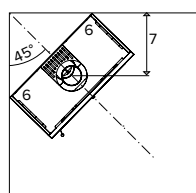

HWAM Classic 4

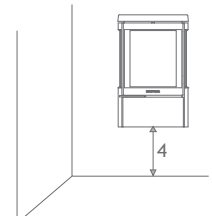
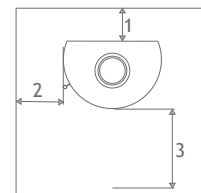
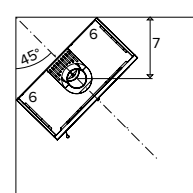

Test results

	EN 13240/13229					NS 3058 NS 3059
	CO at 13% O ₂	CO at 13% O ₂	Particle emission at 13% O ₂	Flue gas temperature measured in the outlet socket	Flue gas mass flow	Particle emission
	%	mg/m ³ _n	mg/m ³ _n	°C	g/s	g/kg
HWAM 2610, Autopilot™	0.08	1003	24	329	3.90	3.42
HWAM 2620, Autopilot™	0.08	1003	24	329	3.90	3.42
HWAM 2630, Autopilot™	0.08	1003	24	329	3.90	3.42
HWAM 2640, Autopilot™	0.08	1003	24	329	3.90	3.42
HWAM 3110, Autopilot™	0.07	906	13	289	5.00	2.05
HWAM 3120, Autopilot™	0.07	906	13	289	5.00	2.05
HWAM 3120, SmartControl™	0.08	1050	12	323	3.50	2.45
HWAM 3130, Autopilot™	0.07	906	13	289	5.00	2.05
HWAM 3130, SmartControl™	0.08	1050	12	323	3.50	2.45
HWAM 3520, Autopilot™	0.07	906	13	289	5.00	2.05
HWAM 3520, SmartControl™	0.08	1050	12	323	3.50	2.45
HWAM 3630, Autopilot™	0.09	1125	18	350	6.00	1.21
HWAM 3630, SmartControl™	0.10	1250	21	325	5.04	1.78
HWAM 3640, Autopilot™	0.09	1125	18	350	6.00	1.21
HWAM 3640, SmartControl™	0.10	1250	21	325	5.04	1.78
HWAM 3650, Autopilot™	0.09	1125	18	350	6.00	1.21
HWAM 3650, SmartControl™	0.10	1250	21	325	5.04	1.78
HWAM 3660, Autopilot™	0.09	1125	18	350	6.00	1.21
HWAM 3660, SmartControl™	0.10	1250	21	325	5.04	1.78
HWAM 3740, Autopilot™	0.07	906	13	289	5.00	2.05
HWAM 3740, SmartControl™	0.08	1050	12	323	3.50	2.45
HWAM 3760, Autopilot™	0.07	906	13	289	5.00	2.05
HWAM 3760, SmartControl™	0.08	1050	12	323	3.50	2.45

NB! Due to the constant improvements of our products the valid values may vary from the above mentioned. Updated values are available at your local HWAM retailer and can be seen on www.hwam.com.

Test results

	EN 13240/13229					NS 3058
	CO at 13% O ₂	CO at 13% O ₂	Particle emission at 13% O ₂	Flue gas temperature measured in the outlet socket	Flue gas mass flow	NS 3059
	%	mg/m ³ _n	mg/m ³ _n	°C	g/s	g/kg
HWAM 4510, Autopilot™	0.08	1000	24	312	4.1	3.01
HWAM 4510, SmartControl™	0.06	750	19	324	4.0	2.16
HWAM 4520, Autopilot™	0.08	1000	24	312	4.1	3.01
HWAM 4520, SmartControl™	0.06	750	19	324	4.0	2.16
HWAM 4530, Autopilot™	0.08	1000	24	312	4.1	3.01
HWAM 4530, SmartControl™	0.06	750	19	324	4.0	2.16
HWAM 4540, Autopilot™	0.08	1000	24	312	4.1	3.01
HWAM 4540, SmartControl™	0.06	750	19	324	4.0	2.16
HWAM 4550, Autopilot™	0.08	1000	24	312	4.1	3.01
HWAM 4550, SmartControl™	0.06	750	19	324	4.0	2.16
HWAM 4560, Autopilot™	0.08	1000	24	312	4.1	3.01
HWAM 4560, SmartControl™	0.06	750	19	324	4.0	2.16
HWAM 4620, Autopilot™	0.08	1000	28	320	5.9	1.74
HWAM 4640, Autopilot™	0.08	1000	28	320	5.9	1.74
HWAM 4640, SmartControl™	0.06	750	29	334	6.6	1.88
HWAM 4660, Autopilot™	0.08	1000	28	320	5.9	1.74
HWAM 4660, SmartControl™	0.06	750	29	334	6.6	1.88
HWAM 5530, Autopilot™	0.061	758	16	326	5.5	2.65
HWAM 5530, SmartControl™	0.077	963	16	299	4.6	1.87
HWAM Classic 4, Autopilot™	0.10	1250	36	255	9.90	-
HWAM I 40/55 Autopilot™	0.061	758	16	326	5.5	2.65
HWAM I 40/55 SmartControl™	0.077	963	16	299	4.6	1.87

NB! Due to the constant improvements of our products the valid values may vary from the above mentioned. Updated values are available at your local HWAM retailer and can be seen on www.hwam.com.

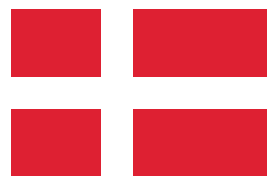

MADE IN
DENMARK

